

ABISKO

Claesson Koivisto Rune

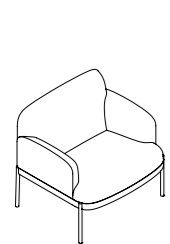

ARMCHAIR
POLTRONA - FAUTEUIL

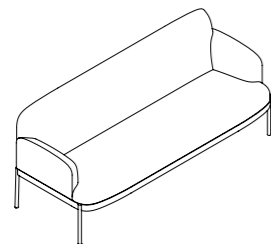

2 SEATER SOFA
DIVANO - CANAPÉ

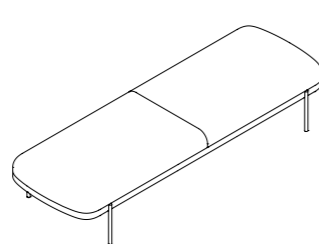

BENCH
PANCA - BANC

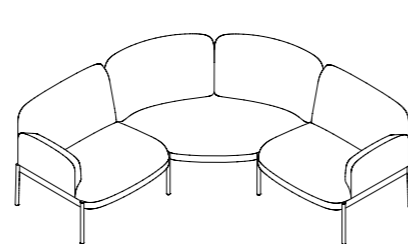

MODULAR BENCH
PANCA MODULARE - BANC MODULAIRE

COLORS AND MATERIALS

COLORI E MATERIALI - COULEURS ET MATÉRIAUX

WOOD LEGNO - BOIS



ashwood
frassino
frêne

oakwood
rovere
chêne

The standard finish are oakwood or ashwood.
Customized RAL colors are available upon request.

La finitura standard sono il rovere o il frassino.
Colori RAL personalizzati sono disponibili su richiesta.

La finition standard est le chêne ou le frêne.
Sur demande, d'autres couleurs spéciales sont disponibles en RAL.

LACQUERED MDF FRAME FOR COFFEE TABLES

STRUTTURA IN MDF LACCATO PER TAVOLINI
STRUCTURE EN MDF LAQUÉ POUR TABLES BASSES



STEEL FEET PIEDI IN ACCIAIO - PIEDS EN ACIER



Click on the icon to see the standard RAL finishings for the steel bases on the dedicated page. Customized RAL colors finishings are available upon request.

Clicca sull'icona per vedere le finiture RAL standard delle basi in acciaio sulla pagina dedicata. Su richiesta sono disponibili colorazioni customizzate su altre tinte RAL.

Cliquez sur l'icône pour voir les finitions RAL standard des bases en acier sur la page dédiée. Des couleurs RAL personnalisées sont disponibles sur demande.

TECHNICAL FEATURES

SPECIFICHE TECNICHE - SPÉCIFICATIONS TECHNIQUES

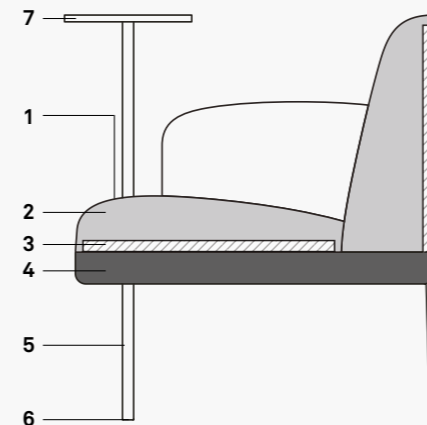

1. Upholstery

Rivestimento
Revêtement

2. High resistance foam

Poliuretano espanso indeformabile
Mousse haute densité

3. Wooden inner frame

Struttura interna in legno
Structure interne en bois

4. Solid oak or MDF frame edge

Struttura esterna in rovere massello o MDF
Structure extérieure en chêne massif ou MDF

5. Steel tube legs

Gambe in tubo d'acciaio
Pieds en tube d'acier

6. Felt pad

Feltrino
Freutre

7. Oakwood coffee table

Tavolino in rovere
Table basse en chêne

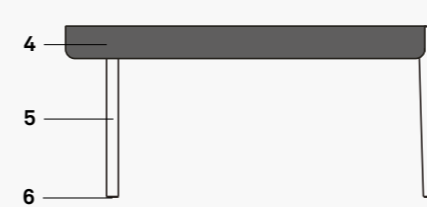

Internal structure in multilayer wood, polyurethane foam padding; external structure in solid oakwood and frame with 4 varnished steel legs.

Struttura interna in multistrato, imbottitura in poliuretano espanso; struttura esterna in rovere massello e telaio con 4 gambe in acciaio verniciato.

Structure interne en contreplaqué, rembourrage en mousse polyuréthane; structure extérieure en chêne massif et structure à 4 pieds en acier peint.

COFFEE TABLE VARIANTS

VARIANTI TAVOLINO - VARIANTES DE TABLE BASSE



Available for the two front legs
Disponibile per le due gambe anteriori
Disponible pour les deux pieds avant

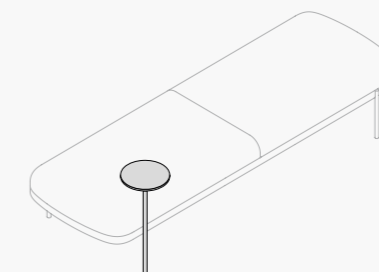

Available for all legs
Disponibile per tutte le gambe
Disponible pour tout le pieds

AB 1000
armchair
poltrona
fauteuil

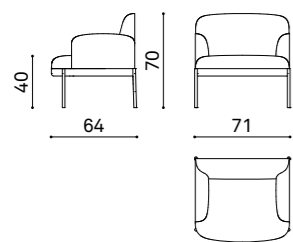

m 1,75 ☆ mq 3,8 📦 kg 18,5 🛠 mc 0,3

AB 5P0R
pouf
pouf
pouf

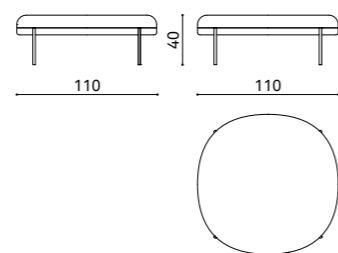

m 2,4 ☆ mq 4,4 📦 kg 20 🛠 mc 0,4

AB PSB2
USB 5V A+C, 2 mt. of cable, power socket
USB 5V A+C, 2 mt. di cavo, presa corrente
USB 5V A+C, 2 mt. de câble, prise de courant

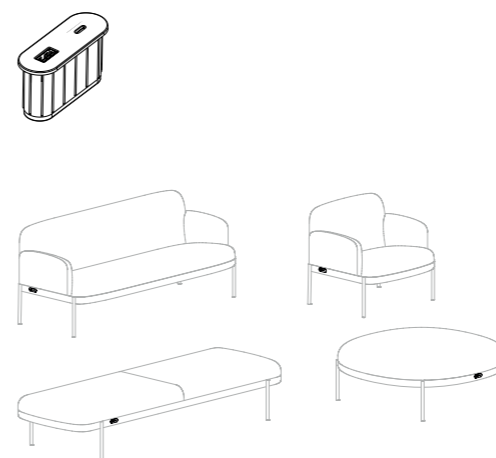

AB T25FS
coffee table
tavolino
table basse

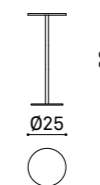

📦 kg 0,6 🛠 mc 0,05

AB 2000
2 seater sofa
divano 2 posti
canapé 2 places

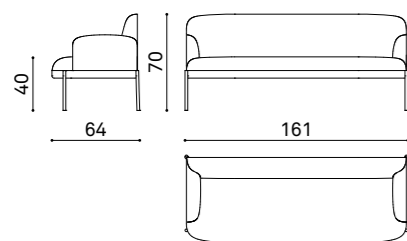

m 3,3 ☆ mq 6,0 📦 kg 36 🛠 mc 0,7

AB 3P00
bench
panca
banc

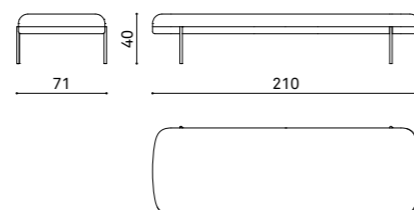

m 2,4 ☆ mq 4,4 📦 kg 30 🛠 mc 0,59

AB T25R
coffee table
tavolino
table basse

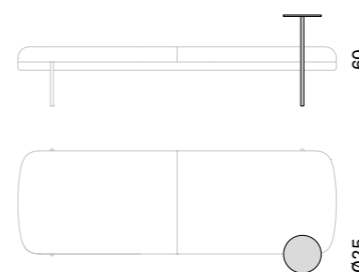

📦 kg 0,2 🛠 mc 0,05

AB CXT25
central coffee table
tavolino centrale
table basse centrale

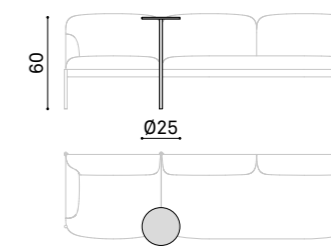

📦 kg 0,2 🛠 mc 0,05

AB 3000
3 seater sofa
divano 3 posti
canapé 3 places

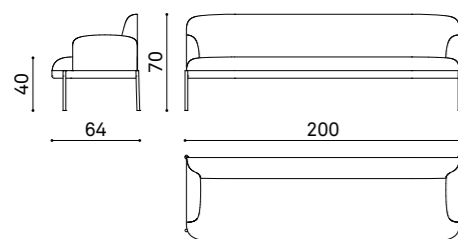

m 5,5 ☆ mq 10

AB 1L00
left armchair
poltrona sinistra
fauteuil gauche

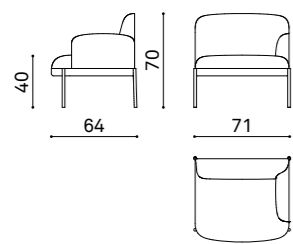

m 1,65 ☆ mq 3,2 📦 kg 17,5 🛠 mc 0,3

AB 1R00
right chair
poltrona destra
fauteuil droit

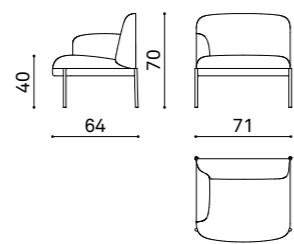

AB 1C00
central armchair
poltrona centrale
fauteuil central

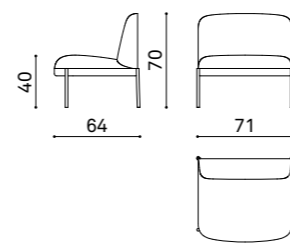

m 1,8 ☆ mq 4 📦 kg 16,5 🛠 mc 0,3

AB L140
left sofa
divano sinistro
canapé gauche

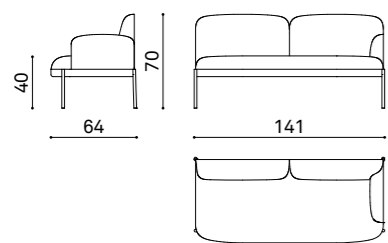

m 5 ☆ mq 10 📦 kg 30 🛠 mc 0,63

AB R140
right sofa
divano destro
canapé droit

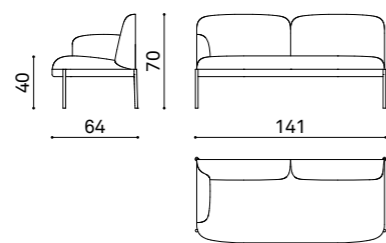

AB C140
central sofa
divano centrale
canapé central

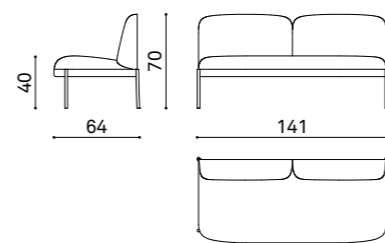

m 4,6 ☆ mq 9 📦 kg 29 🛠 mc 0,63

AB L160
left sofa
divano sinistro
canapé gauche

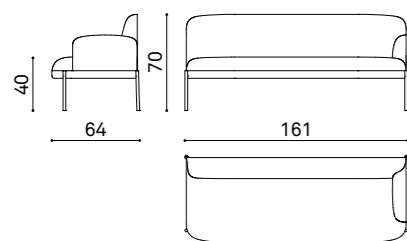

m 4,4 ☆ mq 9 📦 kg 35 🛠 mc 0,7

AB R160
right sofa
divano destro
canapé droit

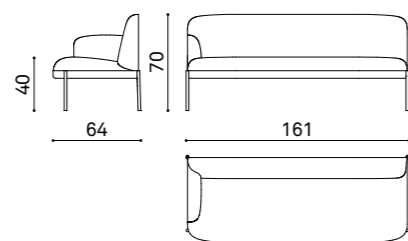

AB C160
central sofa
divano centrale
canapé central

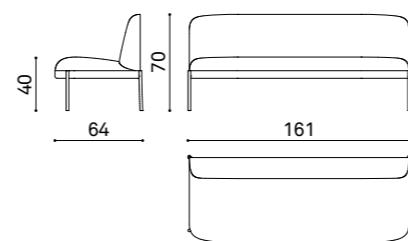

m 4 ☆ mq 8 📦 kg 34 🛠 mc 0,7

AB 90CV
central sofa
divano centrale
canapé central

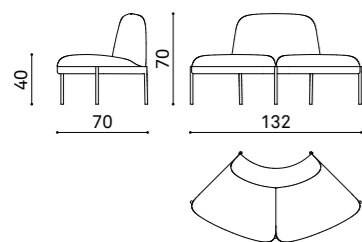

m 2,15 ☆ mq 5 ✎ mc 0,64

AB 45CV
central sofa
divano centrale
canapé central

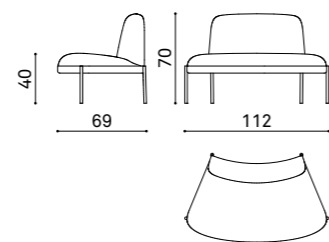

m 2,05 ☆ mq 4,2 ✎ mc 0,54

AB 90CX
central sofa
divano centrale
canapé central

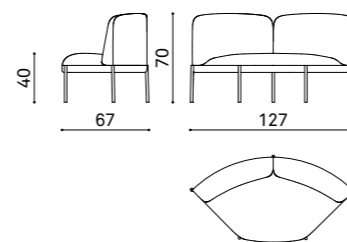

m 2,9 ☆ mq 6 ✎ mc 0,59

AB 45CX
central sofa
divano centrale
canapé central

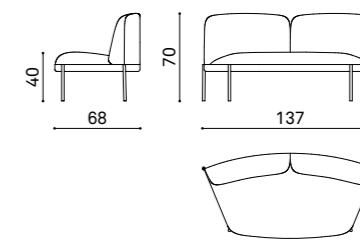

m 2,45 ☆ mq 5 ✎ mc 0,65

AB 90CVR/L
terminal sofa
divano terminale
canapé terminal

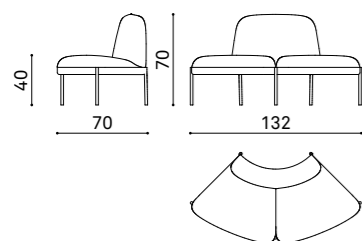

m 2,15 ☆ mq 5 ✎ mc 0,63

AB 45CVR/L
terminal sofa
divano terminale
canapé terminal

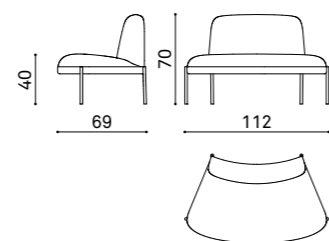

m 2,05 ☆ mq 4,2 ✎ mc 0,54

AB 90CXR/L
terminal sofa
divano terminale
canapé terminal

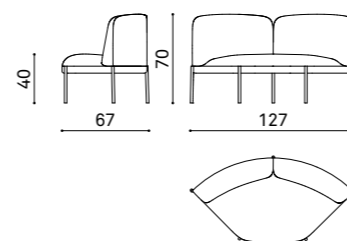

m 2,9 ☆ mq 6 ✎ mc 0,59

AB 45CXR/L
terminal sofa
divano terminale
canapé terminal

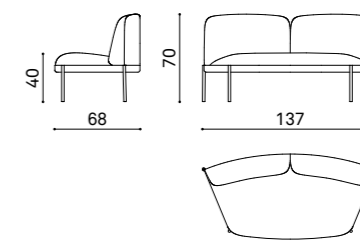

m 2,45 ☆ mq 5 ✎ mc 0,65

AB TCX0
coffee table
tavolino
table basse

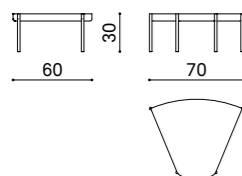

kg 16,8 ✎ mc 0,12

AB TCV0
coffee table
tavolino
table basse

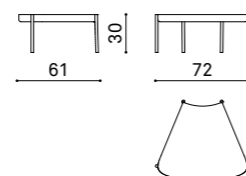

kg 16,9 ✎ mc 0,13

AB TCS0
coffee table
tavolino
table basse

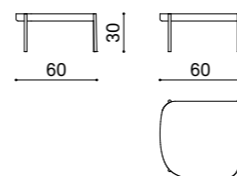

kg 14 ✎ mc 0,1

AB TCC0
coffee table
tavolino
table basse

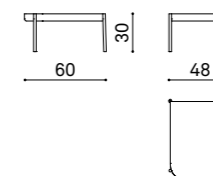

kg 11 ✎ mc 0,08

CONFIGURATION EXAMPLE 1

ESEMPIO COMPOSIZIONE 1 - EXEMPLE CONFIGURATION 1

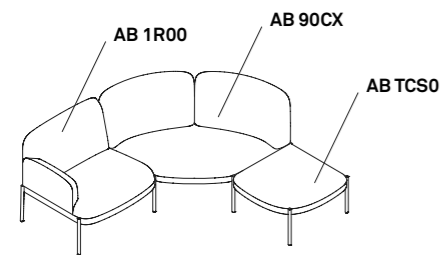

216 W x 115 D x 70 H

CONFIGURATION EXAMPLE 2

ESEMPIO COMPOSIZIONE 2 - EXEMPLE CONFIGURATION 2

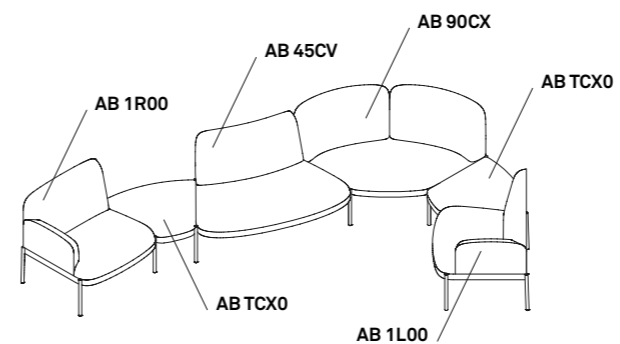

340 W x 187 D x 70 H

CONFIGURATION EXAMPLE 3

ESEMPIO COMPOSIZIONE 3 - EXEMPLE CONFIGURATION 3

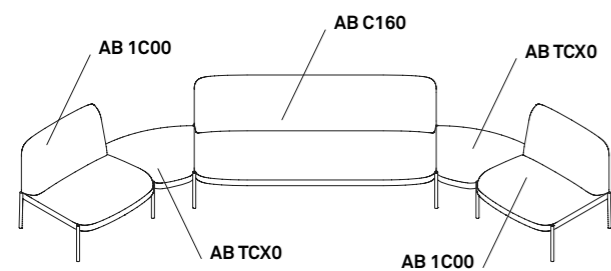

388 W x 115 D x 70 H

CONFIGURATION EXAMPLE 4

ESEMPIO COMPOSIZIONE 4 - EXEMPLE CONFIGURATION 4

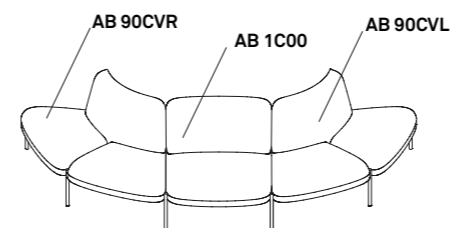

261 W x 100 D x 70 H

CONFIGURATION EXAMPLE 5

ESEMPIO COMPOSIZIONE 5 - EXEMPLE CONFIGURATION 5

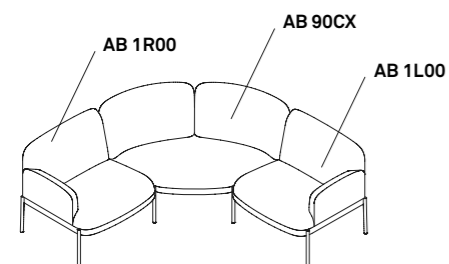

226 W x 115 D x 70 H

CONFIGURATION EXAMPLE 6

ESEMPIO COMPOSIZIONE 6 - EXEMPLE CONFIGURATION 6

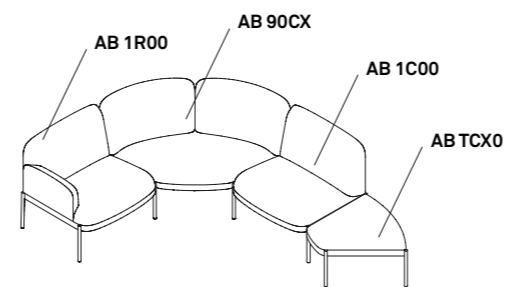

253 W x 140 D x 70 H

CONFIGURATION EXAMPLE 7

ESEMPIO COMPOSIZIONE 7 - EXEMPLE CONFIGURATION 7

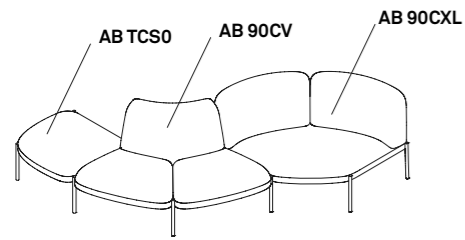

257 W x 105 D x 70 H

CONFIGURATION EXAMPLE 8

ESEMPIO COMPOSIZIONE 8 - EXEMPLE CONFIGURATION 8

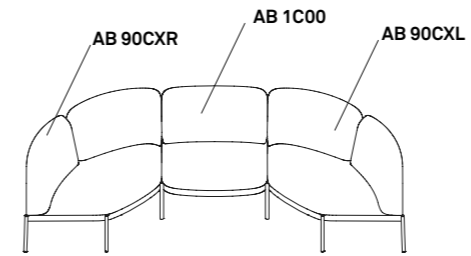

350 W x 90 D x 70 H

CONFIGURATION EXAMPLE 9

ESEMPIO COMPOSIZIONE 9 - EXEMPLE CONFIGURATION 9

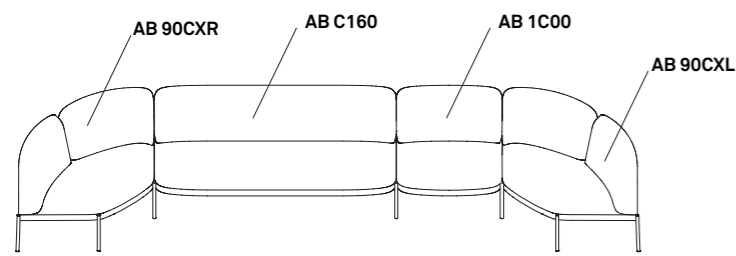

410 W x 90 D x 70 H

CONFIGURATION EXAMPLE 10

ESEMPIO COMPOSIZIONE 10 - EXEMPLE CONFIGURATION 10

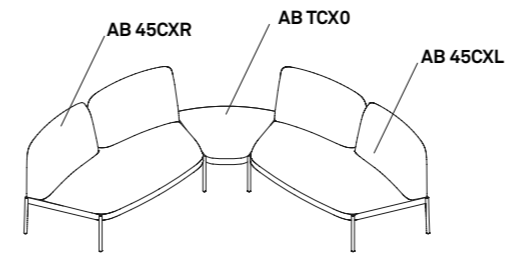

265 W x 125 D x 70 H

CONFIGURATION EXAMPLE 11

ESEMPIO COMPOSIZIONE 11 - EXEMPLE CONFIGURATION 11

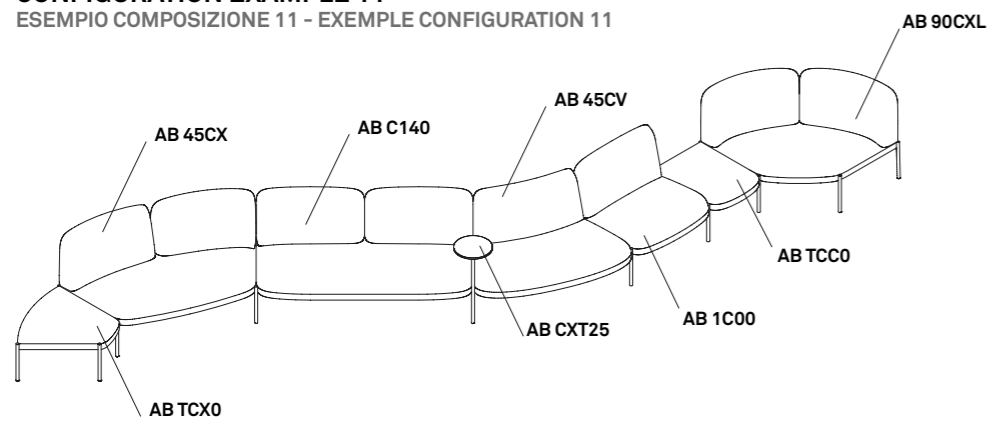

560 W x 270 D x 70 H

CONFIGURATION EXAMPLE 12

ESEMPIO COMPOSIZIONE 12 - EXEMPLE CONFIGURATION 12

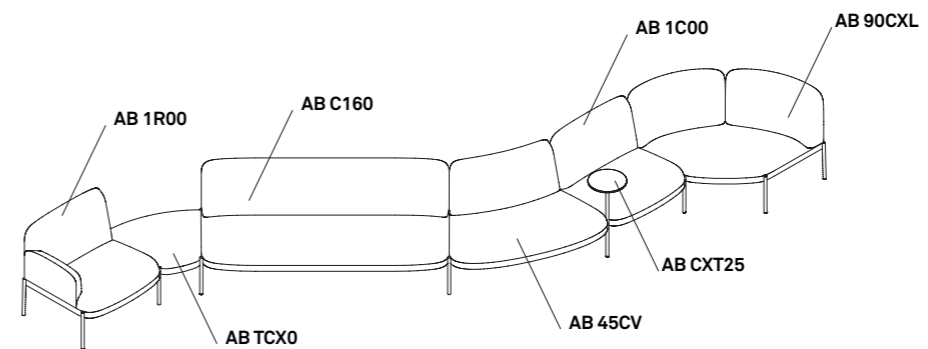

472 x 258 D x 70 H

COLLECTION UPHOLSTERY CATEGORIES

CATEGORIE RIVESTIMENTI A COLLEZIONE - CATÉGORIES DE REVÊTEMENTS EN COLLECTION

S	camira	ERA	100% Polyester 100% Poliestere - 100% Polyester
	FIDIVI	LASER N	100% Polyester Trevira CS 100% Poliestere Trevira CS - 100% Polyester Trevira CS
	FIDIVI	MAYA	100% Polyester Trevira CS 100% Poliestere Trevira CS - 100% Polyester Trevira CS
	Gabriel	CURA	100% Post-consumer recycled polyester, 100% Poliestere riciclato, 100% Polyester recyclé
T	FIDIVI	SEALIFE	100% Recycled Polyester 100% Poliestere riciclato - 100% Polyester recyclé
	FIDIVI	CORTE	100% Polyester Trevira CS 100% Poliestere Trevira CS - 100% Polyester Trevira CS
	SPRADLING®	VALENCIA	Vinyl / Urethane Topcoat Finitura in vinile / uretano - Revêtement de finition vinyle / uréthane
	camira	MAIN LINE FLAX	70% Virgin Wool, 30% Flax 70% Lana Vergine, 30% Lino - 70% Laine vierge, 30% Lin
	Gabriel	CONTOUR - CONTOUR MELANGE	100% Post-consumer recycled polyester, 100% Poliestere riciclato, 100% Polyester recyclé
	Gabriel	STEP	100% Polyester Trevira CS 100% Poliestere Trevira CS - 100% Polyester Trevira CS
M	Gabriel	STEP MELANGE	100% Polyester Trevira CS 100% Poliestere Trevira CS - 100% Polyester Trevira CS
	kvadrat	FIELD 2	100% Polyester Trevira CS 100% Poliestere Trevira CS - 100% Polyester Trevira CS
	Gabriel	FOCUS	100% New Zealand wool 100% lana della Nuova Zelanda - 100% laine de Nouvelle-Zélande
	Gabriel	FOCUS MELANGE	100% New Zealand wool 100% lana della Nuova Zelanda - 100% laine de Nouvelle-Zélande
	Gabriel	GRAIN	92% Post-consumer recycled polyester, 8% Polyester 92% Poliestere riciclato, 8% Poliestere 92% Polyester recyclé, 8% Polyester
	Gabriel	FAME	95% New Zeland Wool, 5% Polyamide 95% ana della Nuova Zelanda, 5% Poliammide 95% laine de Nouvelle-Zélande, 5% Polyamide
	mariosirtori	COIL	50% Cotton, 19% Acrylic, 17% Polyester, 7% Viscose, 7% Wool 50% Cotone, 19% Acrilico, 17% Poliestere, 7% Viscosa, 7% Lana 50% Coton, 19% Acrylique, 17% Polyester, 7% Viscose, 7% Laine
	F	camira	SYNERGY
kvadrat		REMIX 3	90% New wool (worsted), 10% Nylon 90% Lana vergine (pettinata), 10% Nylon - 90% Laine vierge (peignée), 10% Nylon
Gabriel		UMBER	85% New Zeland Wool, 15% Polyamide 85% lana della Nuova Zelanda, 15% Poliammide 85% laine de Nouvelle-Zélande, 15% Polyamide
mariosirtori		LOOP	39% Acrylic, 38% Cotton, 8% Linen, 7% Polyamide, 5% Polyester, 3% Wool 39% Acrilico, 38% Cotone, 8% Lino, 7% Poliammide, 5% Poliestere, 3% Lana 39% Acrylique, 38% Coton, 8% Lin, 7% Polyamide, 5% Polyester, 3% Laine
mariosirtori		TWIST	42% Acrylic, 19% Viscose, 19% Recycled Cotton, 13% Polyester, 6% Cotton, 1% Recycled Other Fibers 42% Acrilico, 19% Viscosa, 19% Cotone riciclato, 13% Poliestere, 6% Cotone, 1% Altre fibre riciclate - 42% Acrylique, 19% Viscose, 19% Coton recyclé, 13% Polyester, 6% Coton, 1% Autres fibres recyclées
L	mariosirtori	KNOT	70% Wool, 24% Cotton, 6% Polyester 70% Lana, 24% Cotone, 6% Poliestere - 70% Laine, 24% Coton, 6% Polyester
	Gabriel	NOBEL	100% New Zeland Wool 100% lana della Nuova Zelanda - 100% laine de Nouvelle-Zélande
P	DANI	PANAMA GENUINE LEATHER	Chrome tanned european bovine raw hides Pelle bovina europea ai sali di cromo - Cuir de bovin européenne avec sels de chrome
	Gabriel	CUBIC	100% Polyester 100% Poliestere - 100% Polyester
PX	elmo	BALTIQUE FULL GRAIN LEATHER	European bovine leather Pelle bovina europea - Cuir de bovin européen

COLLECTION OUTDOOR UPHOLSTERY CATEGORIES

CATEGORIE RIVESTIMENTI OUTDOOR A COLLEZIONE
CATÉGORIES DE TISSUS OUTDOOR EN COLLECTION

M	SPRADLING®	MAGLIA	Vinyl / Urethane Topcoat Finitura in vinile / uretano - Revêtement de finition vinyle / uréthane
F	RUBELLI	FIFTYSHADES	100% PL flame retardant 100% PL ignifugo - 100% PL ignifuge
L	RUBELLI	DIECIELODE	100% PL flame retardant 100% PL ignifugo - 100% PL ignifuge
		FABTHIRTY	100% PL flame retardant 100% PL ignifugo - 100% PL ignifuge
	TEMPOTEST. ITALIAN PERFORMANCE FABRICS	HOME - TINTA UNITA	100% solution dyed outdoor acrylic fibre, available only for the support bands of "Farfalla" 100% fibra acrilica outdoor tinta in massa, disponibile solo per le fasce di supporto di "Farfalla". 100% fibre acrylique teintée dans la masse pour l'extérieur, disponible uniquement pour les bandes de support "Farfalla".

* For the materials selected as "COLLECTION", True design commits to provide supporting marketing tools, including fabric swatches, in quantities and methods compatible with each client's commercial needs.

* Per i materiali selezionati a "COLLEZIONE", True design si impegna a fornire gli strumenti di marketing a supporto, inclusi i campioni tessuto, in quantità e modalità compatibili con le esigenze commerciali di ciascun cliente.

* Pour les matériaux sélectionnés dans la "COLLECTION", True design s'engage à fournir les outils de marketing de soutien, y compris les échantillons de revêtements, en quantités et de manières compatibles avec les besoins commerciaux de chaque client.

OUTDOOR USE AND MAINTENANCE

USO E MANUTENZIONE PER L'OUTDOOR - UTILISATION ET MAINTENANCE POUR L'EXTÉRIUR



STEEL
METALLO - MÉTAL

Steel is used in the manufacture of metal products. This material galvanised and powder-coated, is ideal for outdoor use. Regarding products intended for seaside locations we recommend cleaning on a quarterly basis, with a cloth using water or mild detergents. During the winter period we recommend storing the furniture in closed, dry rooms in order to prevent condensation. In fact, although our products are suitable for outdoor use, during colder months the products should be stored in a closed, dry place in order to prevent moisture and seasonal frosts from affecting the finish.

Nella realizzazione dei prodotti metallici viene impiegato l'acciaio, il quale in seguito al processo di zincatura e di verniciatura a polveri, risulta ideale per l'utilizzo outdoor. Durante il periodo invernale consigliamo di conservare gli arredi in luoghi chiusi ed asciutti per evitare la formazione di condensa. Per i prodotti destinati a località marittime consigliamo con cadenza trimestrale una pulizia con un panno utilizzando acqua o detersivi non aggressivi. Nonostante i nostri prodotti siano adatti all'ambiente esterno, durante il periodo invernale è consigliato il ricovero dei prodotti in un luogo chiuso ed asciutto, in modo da evitare che l'umidità unita alle gelate stagionali possa in qualche modo intaccare le finiture.

L'acier est la matière première utilisée dans la fabrication de ces produits métalliques qui, après un processus de galvanisation et un revêtement de finition par poudre, sont idéaux pour une utilisation en extérieur. Pour les produits destinés à être utilisés en bord de mer, nous recommandons un nettoyage trimestriel avec un chiffon utilisant de l'eau ou des détergents doux. Bien que nos produits soient adaptés à un usage extérieur, nous recommandons de les stocker dans un endroit fermé et sec pendant l'hiver; ceci afin d'éviter que l'humidité combinée aux gelées saisonnières n'affecte d'une manière ou d'une autre les finitions.

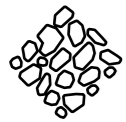

STONE
PIETRA - PIERRE

The stone tops are made of Marble or Santa Margherita and they are ideal for the outdoor environment. Use a soft cloth with just water for daily cleaning. Avoid the use of aggressive abrasive sponges or steel wool pads. The furnishings made of stone such as marble and Santa Margherita, during the first week of use will undergo a slight dulling due to contact with external elements. This is a natural phenomenon which does not affect the quality of the material. When the furniture is placed in seaside locations or swimming pools, cleaning with fresh water on a quarterly basis is recommended in order to avoid water corrosion due to salt build-up or chlorosis. Although our products are suitable for outdoor use, during colder months the products should be stored in a closed, dry place in order to prevent moisture and seasonal frosts from affecting the finish.

Materiale composito autoportante adatto all'ambiente Outdoor. Utilizzare un panno morbido con sola acqua per la pulizia quotidiana. In caso di necessità utilizzare detersivi non aggressivi. Evitare l'impiego di spugne abrasive o pagliette in acciaio. Nel caso di collocamento degli arredi in località marittime o piscine, si consiglia una pulizia trimestrale utilizzando acqua dolce per evitare principi di corrosione dovuti ad accumuli salini o clorosi. Nonostante i nostri prodotti siano adatti all'ambiente esterno, durante il periodo invernale è consigliato il ricovero dei prodotti in un luogo chiuso ed asciutto, in modo da evitare che l'umidità unita alle gelate stagionali possa in qualche modo intaccare le finiture.

Les dessus en pierre sont en marbre ou en Santa Margherita, idéaux pour une utilisation en extérieur. Utilisez un chiffon doux avec de l'eau uniquement pour le nettoyage quotidien. Évitez d'utiliser des détergents agressifs, des éponges abrasives ou des tampons de laine d'acier. Les meubles en pierre tels que le marbre et la Santa Margherita, pendant la première semaine, subissent un léger ternissement dû au contact avec les éléments extérieurs. Il s'agit d'un phénomène naturel, qui n'affecte pas la qualité du matériau. Si le meuble est placé dans des stations balnéaires ou des piscines, nous recommandons un nettoyage trimestriel à l'eau douce pour éviter la corrosion due à l'accumulation de sel ou à la chlorose. Bien que nos produits conviennent à une utilisation en extérieur, il est recommandé, pendant la période hivernale, de stocker les produits dans un endroit fermé et sec, afin d'éviter que l'humidité combinée aux gelées saisonnières n'affecte d'une manière ou d'une autre la finition.



FABRICS
TESSUTI - TISSU

The fabrics used are naturally resistant to climatic elements, UV-resistant and anti-microbial. After heavy rainfall it is recommended to remove the cushions for quick drying and in order to prevent condensation. When the furniture is placed in seaside locations or swimming pools, cleaning with fresh water on a quarterly basis is recommended in order to avoid water corrosion due to salt build-up or chlorosis. Although our products are suitable for outdoor use, during colder months the products should be stored in a closed, dry place in order to prevent moisture and seasonal frosts from affecting the finish.

I tessuti impiegati sono naturalmente resistenti agli elementi climatici, resistenti ai raggi UV ed anti-microbici. A seguito di forti precipitazioni è consigliato rimuovere i cuscini per un'asciugatura rapida e prevenire la formazione di condensa. Nel caso di collocamento degli arredi in località marittime o piscine, si consiglia una pulizia trimestrale utilizzando acqua dolce per evitare principi di corrosione dovuti ad accumuli salini o clorosi. Nonostante i nostri prodotti siano adatti all'ambiente esterno, durante il periodo invernale è consigliato il ricovero dei prodotti in un luogo chiuso ed asciutto, in modo da evitare che l'umidità unita alle gelate stagionali possa in qualche modo intaccare le finiture.

Les tissus utilisés sont naturellement résistants aux éléments climatiques, résistants aux UV et antimicrobiens. Après de fortes pluies, il est toutefois conseillé de retirer les coussins pour un séchage rapide et pour éviter la formation de condensation. Si le mobilier est placé dans des stations balnéaires ou des piscines, nous recommandons un nettoyage trimestriel à l'eau douce pour éviter la corrosion due à l'accumulation de sel ou de chlore. Bien que nos produits soient adaptés à une utilisation en extérieur, il est recommandé de les stocker dans un endroit fermé et sec pendant la période hivernale, afin d'éviter que l'humidité combinée aux gelées saisonnières n'affecte d'une manière ou d'une autre les finitions.

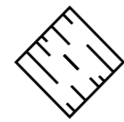

HPL
HPL - HPL

Self-supporting composite material suitable for outdoor environment. Use a soft cloth with water only for daily cleaning. If necessary, use non-aggressive detergents. Please avoid using abrasive sponges or steel wool pads. When the furniture is placed in seaside locations or swimming pools, cleaning with fresh water on a quarterly basis is recommended in order to avoid water corrosion due to salt build-up or chlorosis. Although our products are suitable for outdoor use, during colder months the products should be stored in a closed, dry place in order to prevent moisture and seasonal frosts from affecting the finish.

Materiale composito autoportante adatto all'ambiente Outdoor. Utilizzare un panno morbido con sola acqua per la pulizia quotidiana. In caso di necessità utilizzare detersivi non aggressivi. Evitare l'impiego di spugne abrasive o pagliette in acciaio. Nel caso di collocamento degli arredi in località marittime o piscine, si consiglia una pulizia trimestrale utilizzando acqua dolce per evitare principi di corrosione dovuti ad accumuli salini o clorosi. Nonostante i nostri prodotti siano adatti all'ambiente esterno, durante il periodo invernale è consigliato il ricovero dei prodotti in un luogo chiuso ed asciutto, in modo da evitare che l'umidità unita alle gelate stagionali possa in qualche modo intaccare le finiture.

Matériau composite autoportant adapté à un usage extérieur. Utilisez un chiffon doux avec de l'eau uniquement pour le nettoyage quotidien. Si nécessaire, utilisez des détergents non agressifs. Évitez d'utiliser des éponges abrasives ou des tampons de laine d'acier. Si le mobilier doit être installé dans des stations balnéaires ou des piscines, nous recommandons un nettoyage trimestriel à l'eau douce pour éviter la corrosion due au sel ou au chlore. Bien que nos produits conviennent à une utilisation en extérieur, il est recommandé, pendant la période hivernale, de stocker les produits dans un endroit fermé et sec, afin d'éviter que l'humidité combinée aux gelées saisonnières n'affecte d'une manière ou d'une autre les finitions.

STANDARD STEEL RAL COLORS

COLORI RAL STANDARD PER ACCIAIO - COULEURS RAL STANDARD POUR LE MÉTAL



The standard finishings for the steel elements are the RAL shown. Customized RAL colors finishings are available upon request.

Le finiture standard degli elementi in acciaio sono i RAL mostrati. Su richiesta sono disponibili colorazioni customizzate su altre tinte RAL.

Les finitions standard des éléments en acier sont le RAL illustré. Des couleurs RAL personnalisées sont disponibles sur demande.



CUSTOM

MATERIAL FINISHES AND COLOR SWATCHES

FINITURE MATERIALI E CAMPIONI COLORI - FINITIONS ET ÉCHANTILLONS COULEURS

DOWNLOAD

Click on the image above to download the material finishes and color swatches

Clicca sull'immagine per scaricare il pdf delle finiture dei materiali e dei campioni colori

Cliquez sur l'image associée pour télécharger les finitions et échantillons couleurs

