

IMPACT ACOUSTIC®

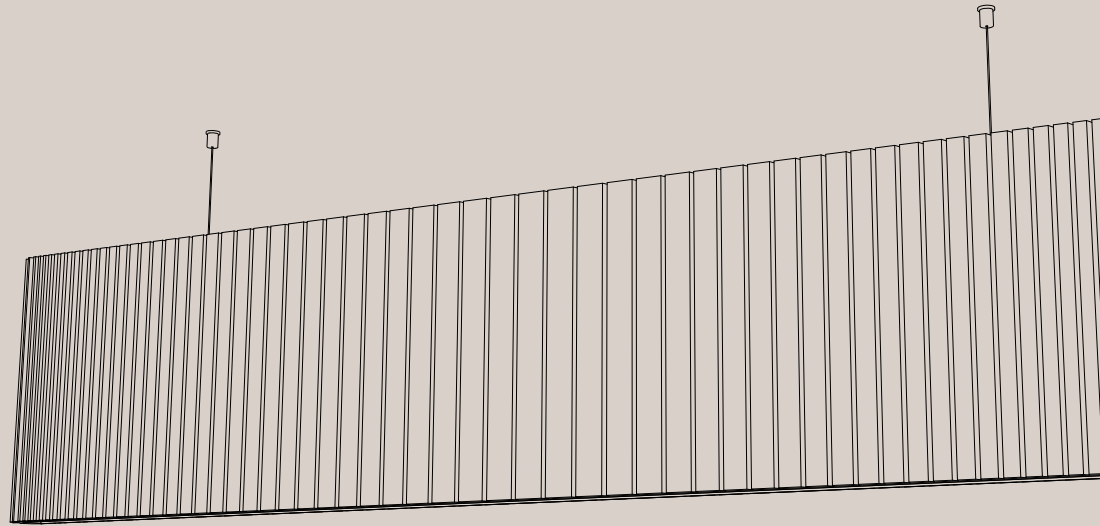

Sensa

Acoustic Lighting

723.12.10.000.00
723.12.11.000.00

TECHNICAL DATA SHEET

Sensa

Acoustic Lighting

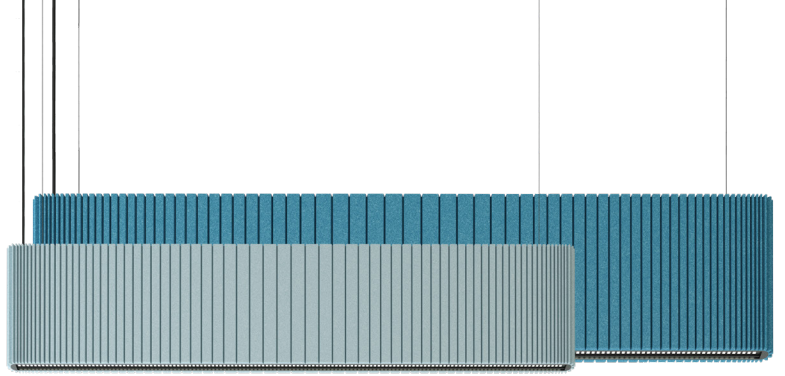

PRODUCT DIMENSIONS

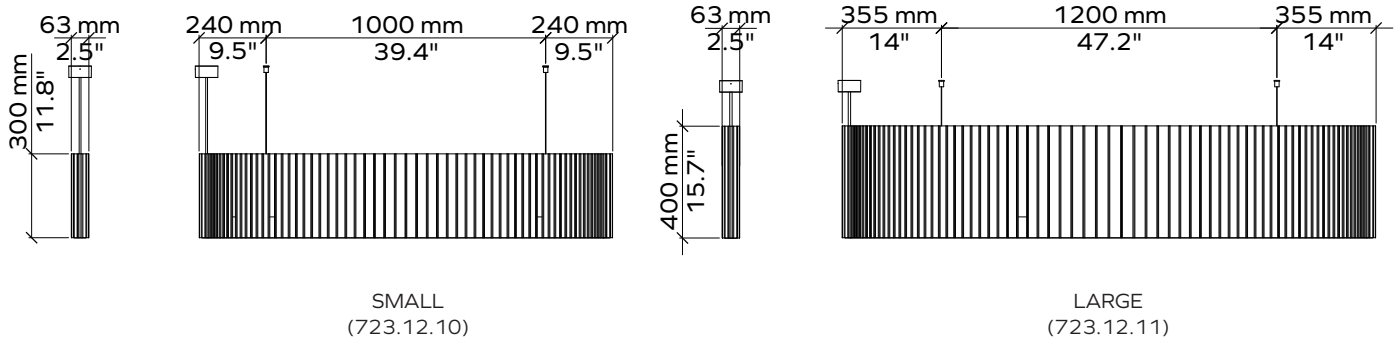

ARTICLE NUMBERS

Lighting Product	Product Size	Colour code	CCT	North American Market
723.12.	10 (Small)	Choose colour as shown on pg. 2	27 (2700K)	Add an A at the end of the CCT code to indicate this product is for North America
	11 (Large)		30 (3000K)	
			35 (3500K)	
			40 (4000K)	

Example: 732.12.10.706.35A

Sensa Small [(1480x300mm / 58.25" x 11.8", Spearmint 706 colour, 3500K CCT, 110-277V (North America)]

LIGHTING SPECIFICATIONS

	Small (723.12.10.)	Large (723.12.11.)
Output	Direct	
Total Lumen Output (lm)	3061	3980
Wattage	31	41
Efficacy (lm/W)	99	97
Diffuser	Glare-free reflector	
Beam Angle	66	
CCT	2700-3000-3500-4000K	
CRI	90+	
MacAdam	3	
Voltage	220 - 240 V / 120V	
Dimming	0.1% DSI/DALI Dimming	
Driver Location	On-Board	

LIGHT DISTRIBUTION GRAPH

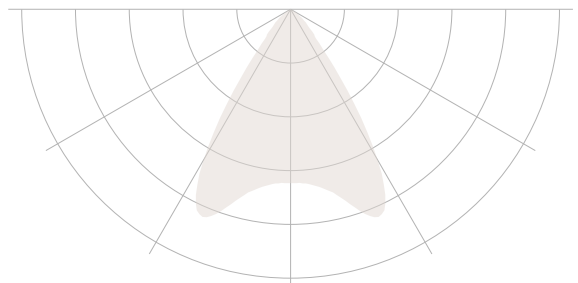

















CERTIFICATIONS











ARCHISONIC® Felt Colours

 Material brochure available

									
Name	Snow White	Milk	Cloud	Gull	Smoke	Ground	Charcoal	Slate	Raven
Code	500	404	103	144	442	108	542	444	550
NCS	S 0300-N	S 0502-Y	S 1002-B	S2502-Y	S 3005-R80B	S 5005-Y20R	S 7502-B	S 4500-N	S 8500-N

									
Name	Nordic Pine	Grove	Fern	Moss	Spearmint	Ice Blue	Succulent	Deep Sea	True Navy
Code	311	317	180	439	706	304	712	918	194
NCS	S 5030-G10Y	S 7020-G30Y	S6010-G90Y	S 2040-G40Y	S 1010-B90G	S 0510-B	S 3020-B30G	S 5020-R90B	S8005-B

									
Name	Lichen	Linen	Shell Pink	Jute	Warm Stone	Terracotta	Soft Coral	Honeycomb	Sunshine
Code	160	107	102	920	105	239	516	139	846
NCS	S4005-Y	S 1505-Y30R	S 0510-R30B	S 3010-Y30R	S 3010-Y50R	S 4040-Y70R	S 2020-Y90R	S 2050-Y20R	S 1040-Y10R

									
Name	Garnet	Hot Pink	Poster Red	Electric Orange	Winter Sky	Pacific Ocean	Midnight	Grape	Marine Blue
Code	724	140	662	464	410	432	810	540	864
NCS	S 5040-R10B	S 2060-R20B	S 1080-R	S 0580-Y70R	S 2020-R90 B	S 3040-B	S 7020-R70B	S 5040-R40B	S 4050-R70B

These NCS codes are the closest visual match available and may not be exact to blended fibres.

ARCHISONIC®

Colours

Experience our ARCHISONIC® Felt material with a stunning selection of 36 colours across 8 distinct families, thoughtfully curated by *Colour Hive* in London. Effortlessly combine colours harmoniously to suit your preferences. Discover more in our Materials brochure and order your free sample box today.

Colour fastness

Class 6
ISO 105-B02:A1

Order a free sample box



Testing Standards

ISO 354:2003	Acoustics — Measurement of sound absorption in a reverberation room
ISO 11654:1997	Acoustics — Sound absorbers for use in buildings — Rating of sound absorption
ISO 20189:2018	Acoustics — Screens, furniture and single objects intended for interior use — Rating of sound absorption and sound reduction of elements based on laboratory measurements
ASTM C423-17	Standard Test Method for Sound Absorption and Sound Absorption Coefficients by the Reverberation Room Method
ASTM E795-16	Standard Practices for Mounting Test Specimens During Sound Absorption Tests

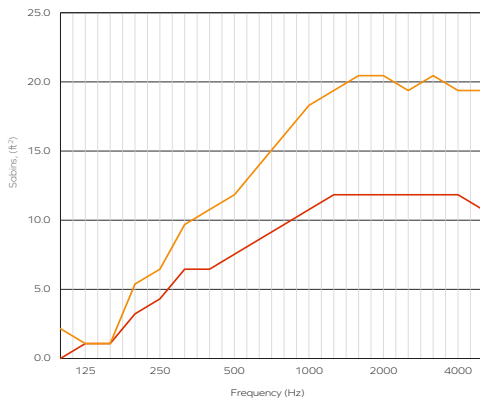

Acoustic Performance - ASTM Sabins, ft²

Frequency (Hz)	125	250	500	1000	2000	4000
12mm Sensa (Small)	1.08	7.53	11.84	18.30	20.45	19.38
12mm Sensa (Large)	1.08	4.31	7.53	10.76	11.84	11.84

The graph represents the Sabins (ft²) in the third octave band center frequencies in accordance with ASTM C423.

- 12mm Sensa (Small)
- 12mm Sensa (Large)

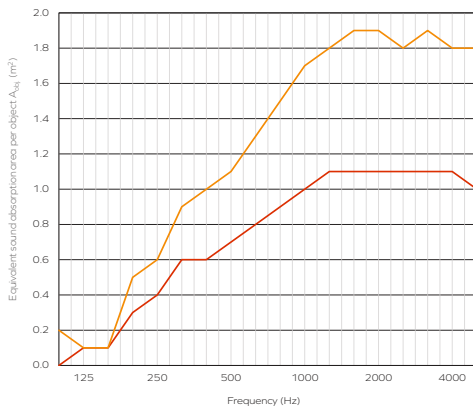

Acoustic Performance - ISO A_{obj}, m²

Frequency (Hz)	125	250	500	1000	2000	4000
12mm Sensa (Small)	0.10	0.40	0.70	1.00	1.10	1.10
12mm Sensa (Large)	0.10	0.70	1.10	1.70	1.90	1.80

The graph represents the equivalent sound absorption per object (A_{obj}) in the third octave band center frequencies in accordance with ISO 20189. Measurement used Pink Noise as excitation signal in a reverberant room.

- 12mm Sensa (Small)
- 12mm Sensa (Large)

ARCHISONIC® Felt

Material Specification

Product Name	ARCHISONIC® Felt	
Content	100% PET (60% certified post-consumer content)	
Thickness¹	12mm (0.47")	24mm (0.94")
Max. Size	1200x2800mm (47"x110")	1800x2400mm (70"x94")
Acoustic²	ASTM: NRC=0.6 ISO: α_w =0.65	ASTM: NRC=0.9 ISO: α_w =0.95
Density¹	2400 g/m ² (0.49 lbs/ sqft)	4000 g/m ² (0.82 lbs/sqft)
Colour Fastness	Class 6 ISO 105-B02:A1	
Colour	36 colours (see ARCHISONIC® Felt Colour page for more information)	
Maintenance	For daily cleaning we recommend alcohol solution (75%), e.g. Pantasept. In case of contamination by dust or fluff, use feather duster or a regular vacuum cleaner. For heavy dirt, treat the material with hydrogen peroxide.	
Production Lead time³	21 days	
Fire Rating	DIN EN 13501-1: B-s1, d0	ASTM E84 Class A
VOC Emission	28 Days French Regulation A+ ASTM E84 Pass Bream® (International, UK, NL, SE, NOR) Exemplary CDPH (CDPH/EHLB/Standard Method V1.2) Pass	
Certifications	Declare label, Cradle to Cradle, UL Environmental Product Declaration, Member of US Green Building Council, Ecobau 1st Priority, Climmate-KIC, VOC emissions in LEED EQ credit (low-emitting products), SCS Recycled Content	
Durability	Contract	

1 - all values are nominal 2 - measured with 300mm air cavity 3 - depending on the location and type of product



Climate-KIC is supported by the EIT, a body of the European Union



Sensa

Acoustic Lighting

Online Resources

A variety of resources are available online for all of our products. Please visit the product's page for more information.



CAD files
IES/LDT files



Spec sheets and
Installation Guide



Colour families



Instruction
videos



Associated
products specs.

Ordering Process

Our experienced team of Project Consultants will guide and support you throughout the order process. We fulfill the majority of our orders in as little as 21 days¹ from your first point of contact, allowing you to focus on what truly matters to you.



Contact our
consultant

Quote¹

48 h



Order Confirmation

Production¹

2 - 3 weeks



Dispatch

Transit

location based



Delivery

Contact Us

Ready to make an impact? We are just an email or call away to discuss your project and answer any question.



+41 41 244 14 00



connect@impactacoustic.com



Online form

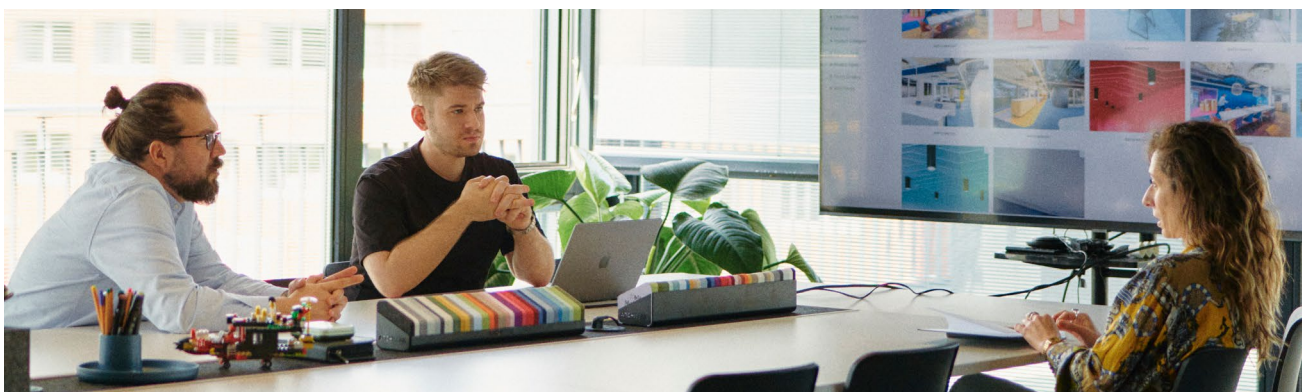

¹ - Quote and Production times may vary.

IMPACT ACOUSTIC®
Acoustic Lighting rev.01 - 12.08.25

(Switzerland)
(USA)
(Philippines)

connect@impactacoustic.com
usa@impactacoustic.com
philippines@impactacoustic.com

(+41) 41 244 1400
(+1) 619 378 2100
(+63) 285 80 02 50

#WeMakeAnImpact

**#We
Make An
Impact**

connect@impactacoustic.com | www.impactacoustic.com