

IMPACT ACOUSTIC®

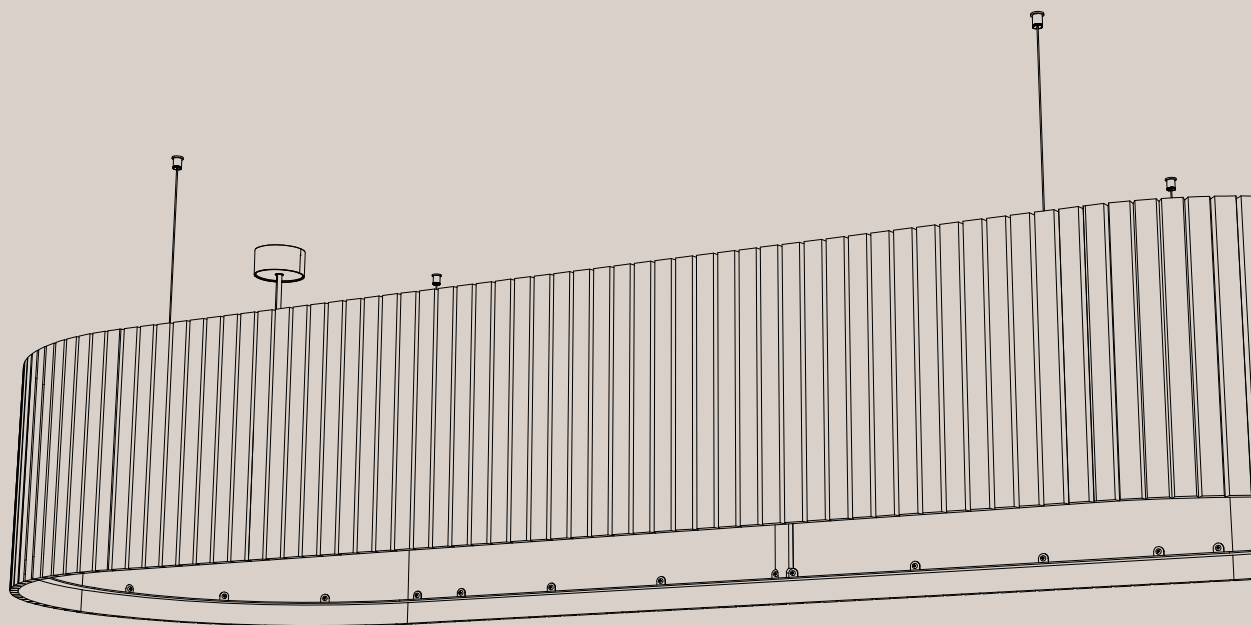

# Umbra Long

## Acoustic Lighting

722.24.12.000.00  
722.24.13.000.00

TECHNICAL DATA SHEET

# Umbra Long

## Acoustic Lighting

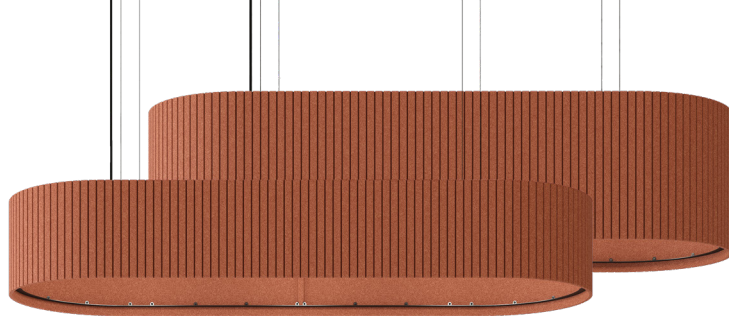

### PRODUCT DIMENSIONS

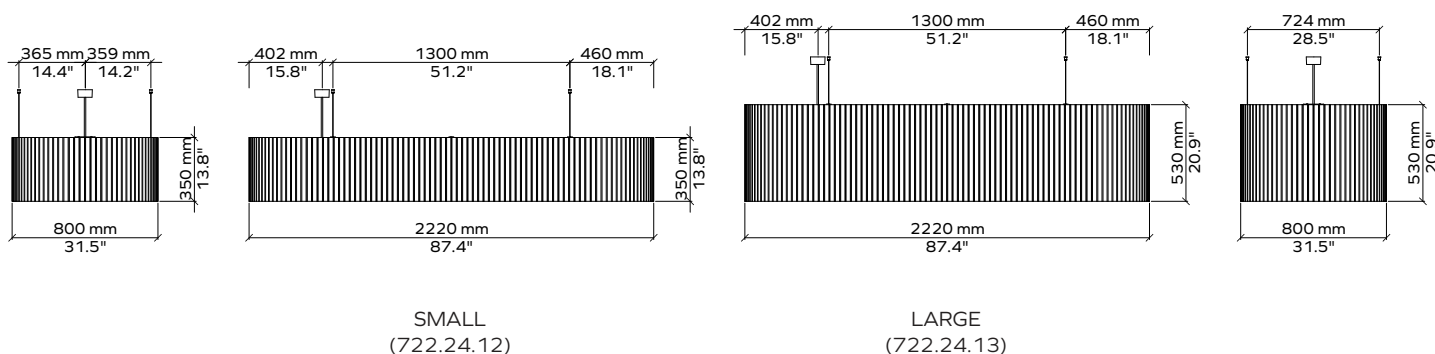

### ARTICLE NUMBERS

Lighting Product	Product Size	Colour code	CCT	North American Market
722.24.	12 (Small) 13 (Large)	Choose colour as shown on pg. 3	27 (2700K)	Add an A at the end of the CCT code to indicate this product is for North America
			30 (3000K)	
			35 (3500K)	
			40 (4000K)	

#### Example: 723.12.12.706.35A

Umbra L Small [(1550 x 135mm/61.22 x 5.31", Spearmint 706 colour, 3500K CCT, 110-277V (North America)]

### LIGHTING SPECIFICATIONS

	For both sizes
Output	Direct
Total Lumen Output (lm)	2700
Wattage	32
Efficacy (lm/W)	84
Diffuser	Microprism
Beam Angle	100
CCT	2700-3000-3500-4000K
CRI	80+
MacAdam	3
Voltage	220 - 240 V / 120V
Dimming	0.1% DSI/DALI Dimming
Driver Location	On-Board

### LIGHT DISTRIBUTION GRAPH

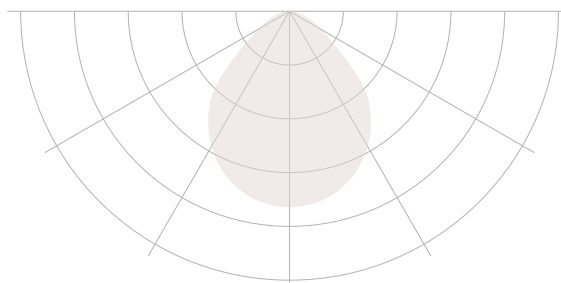

















### CERTIFICATIONS











# ARCHISONIC® Felt Colours

 Material brochure available

									
<b>Name</b>	Snow White	Milk	Cloud	Gull	Smoke	Ground	Charcoal	Slate	Raven
<b>Code</b>	500	404	103	144	442	108	542	444	550
<b>NCS</b>	S 0300-N	S 0502-Y	S 1002-B	S2502-Y	S 3005-R80B	S 5005-Y20R	S 7502-B	S 4500-N	S 8500-N

									
<b>Name</b>	Nordic Pine	Grove	Fern	Moss	Spearmint	Ice Blue	Succulent	Deep Sea	True Navy
<b>Code</b>	311	317	180	439	706	304	712	918	194
<b>NCS</b>	S 5030-G10Y	S 7020-G30Y	S6010-G90Y	S 2040-G40Y	S 1010-B90G	S 0510-B	S 3020-B30G	S 5020-R90B	S8005-B

									
<b>Name</b>	Lichen	Linen	Shell Pink	Jute	Warm Stone	Terracotta	Soft Coral	Honeycomb	Sunshine
<b>Code</b>	160	107	102	920	105	239	516	139	846
<b>NCS</b>	S4005-Y	S 1505-Y30R	S 0510-R30B	S 3010-Y30R	S 3010-Y50R	S 4040-Y70R	S 2020-Y90R	S 2050-Y20R	S 1040-Y10R

									
<b>Name</b>	Garnet	Hot Pink	Poster Red	Electric Orange	Winter Sky	Pacific Ocean	Midnight	Grape	Marine Blue
<b>Code</b>	724	140	662	464	410	432	810	540	864
<b>NCS</b>	S 5040-R10B	S 2060-R20B	S 1080-R	S 0580-Y70R	S 2020-R90 B	S 3040-B	S 7020-R70B	S 5040-R40B	S 4050-R70B

These NCS codes are the closest visual match available and may not be exact to blended fibres.

**ARCHISONIC®**

## Colours

Experience our ARCHISONIC® Felt material with a stunning selection of 36 colours across 8 distinct families, thoughtfully curated by *Colour Hive* in London. Effortlessly combine colours harmoniously to suit your preferences. Discover more in our Materials brochure and order your free sample box today.

## Colour fastness

Class 6  
ISO 105-B02:A1

## Order a free sample box



# Umbra Long

## Acoustic Performance



### Testing Standards

ISO 354:2003	Acoustics — Measurement of sound absorption in a reverberation room
ISO 11654:1997	Acoustics — Sound absorbers for use in buildings — Rating of sound absorption
ISO 20189:2018	Acoustics — Screens, furniture and single objects intended for interior use — Rating of sound absorption and sound reduction of elements based on laboratory measurements
ASTM C423-17	Standard Test Method for Sound Absorption and Sound Absorption Coefficients by the Reverberation Room Method
ASTM E795-16	Standard Practices for Mounting Test Specimens During Sound Absorption Tests

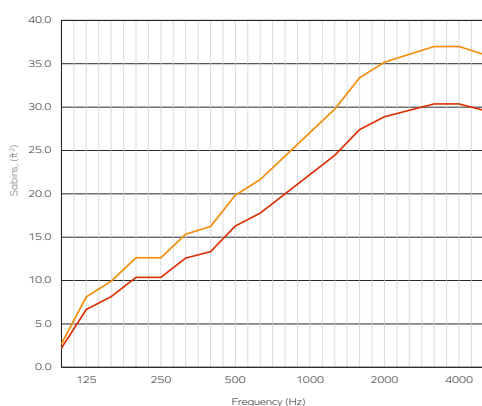

### Acoustic Performance - ASTM Sabins, ft<sup>2</sup>

Frequency (Hz)	125	250	500	1000	2000	4000
12mm Umbra Long (Small)	5.38	10.76	16.15	22.60	29.06	30.14
12mm Umbra Long (Large)	6.46	13.99	19.38	26.91	34.44	36.60

The graph represents the Sabins (ft<sup>2</sup>) in the third octave band center frequencies in accordance with ASTM C423.

- 12mm Umbra Long (Small)
- 12mm Umbra Long (Large)

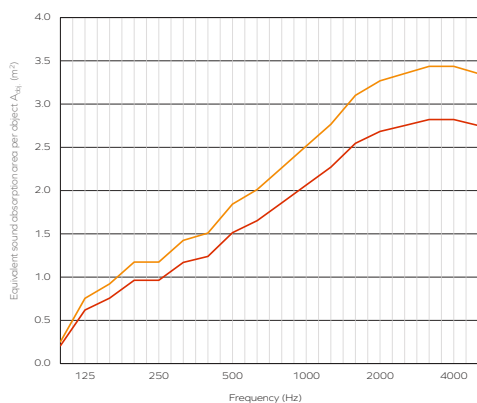

### Acoustic Performance - ISO A<sub>obj</sub>, m<sup>2</sup>

Frequency (Hz)	125	250	500	1000	2000	4000
12mm Umbra Long (Small)	0.50	1.00	1.50	2.10	2.70	2.80
12mm Umbra Long (Large)	0.60	1.30	1.80	2.50	3.20	3.40

The graph represents the equivalent sound absorption per object (A<sub>obj</sub>) in the third octave band center frequencies in accordance with ISO 20189. Measurement used Pink Noise as excitation signal in a reverberant room.

- 12mm Umbra Long (Small)
- 12mm Umbra Long (Large)

# ARCHISONIC® Felt

## Material Specification

<b>Product Name</b>	ARCHISONIC® Felt	
<b>Content</b>	100% PET (60% certified post-consumer content)	
<b>Thickness<sup>1</sup></b>	12mm (0.47")	24mm (0.94")
<b>Max. Size</b>	1200x2800mm (47"x110")	1800x2400mm (70"x94")
<b>Acoustic<sup>2</sup></b>	<b>ASTM:</b> NRC=0.6 <b>ISO:</b> $\alpha_w$ =0.65	<b>ASTM:</b> NRC=0.9 <b>ISO:</b> $\alpha_w$ =0.95
<b>Density<sup>1</sup></b>	2400 g/m <sup>2</sup> (0.49 lbs/ sqft)	4000 g/m <sup>2</sup> (0.82 lbs/sqft)
<b>Colour Fastness</b>	<b>Class 6</b> ISO 105-B02:A1	
<b>Colour</b>	<b>36 colours</b> (see ARCHISONIC® Felt Colour page for more information)	
<b>Maintenance</b>	For daily cleaning we recommend alcohol solution (75%), e.g. Pantasept. In case of contamination by dust or fluff, use feather duster or a regular vacuum cleaner. For heavy dirt, treat the material with hydrogen peroxide.	
<b>Production Lead time<sup>3</sup></b>	21 days	
<b>Fire Rating</b>	DIN EN 13501-1: <b>B-s1, d0</b>	ASTM E84 <b>Class A</b>
<b>VOC Emission</b>	28 Days French Regulation <b>A+</b> ASTM E84 <b>Pass</b> Bream® (International, UK, NL, SE, NOR) <b>Exemplary</b> CDPH (CDPH/EHLB/Standard Method V1.2) <b>Pass</b>	
<b>Certifications</b>	Declare label, Cradle to Cradle, UL Environmental Product Declaration, Member of US Green Building Council, Ecobau 1st Priority, Climmate-KIC, VOC emissions in LEED EQ credit (low-emitting products), SCS Recycled Content	
<b>Durability</b>	Contract	

1 - all values are nominal 2 - measured with 300mm air cavity 3 - depending on the location and type of product



Climate-KIC is supported by the EIT, a body of the European Union



**Declare.**

**DANAK**  
TEST Reg.nr. 522



# Umbra Long

## Acoustic Lighting

### Online Resources

A variety of resources are available online for all of our products. Please visit the product's page for more information.



CAD files  
IES/LDT files



Spec sheets and  
Installation Guide



Colour families



Instruction  
videos



Associated  
products specs.

### Ordering Process

Our experienced team of Project Consultants will guide and support you throughout the order process. We fulfill the majority of our orders in as little as 21 days<sup>1</sup> from your first point of contact, allowing you to focus on what truly matters to you.



Contact our  
consultant

Quote<sup>1</sup>

48 h



Order Confirmation

Production<sup>1</sup>

2 - 3 weeks



Dispatch

Transit

location based



Delivery

### Contact Us

Ready to make an impact? We are just an email or call away to discuss your project and answer any question.



+41 41 244 14 00



connect@impactacoustic.com



Online form

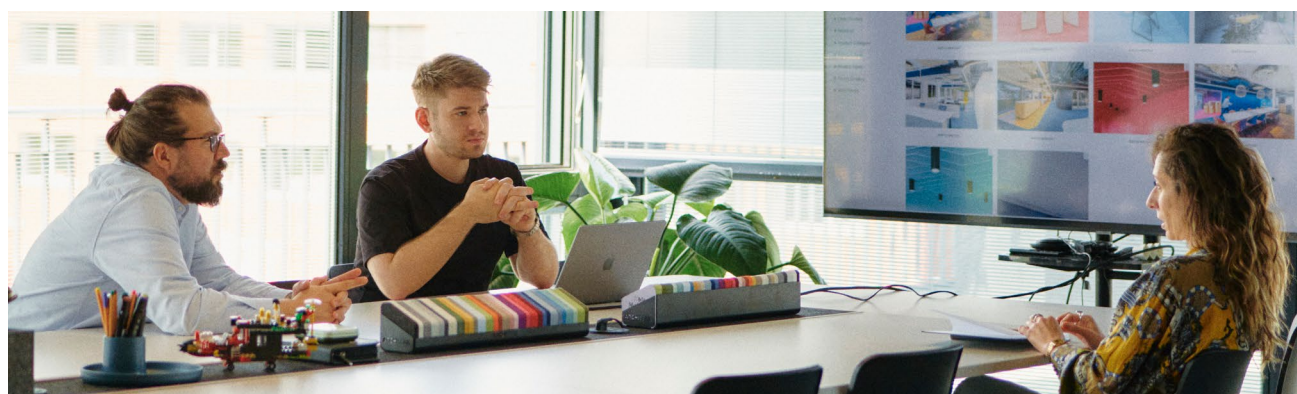

<sup>1</sup> - Quote and Production times may vary.

**IMPACT ACOUSTIC®**  
Acoustic Lighting rev.01 - 13.08.25

(Switzerland)  
(USA)  
(Philippines)

connect@impactacoustic.com  
usa@impactacoustic.com  
philippines@impactacoustic.com

(+41) 41 244 1400  
(+1) 619 378 2100  
(+63) 285 80 02 50

#WeMakeAnImpact

**#We  
Make An  
Impact**

[connect@impactacoustic.com](mailto:connect@impactacoustic.com) | [www.impactacoustic.com](http://www.impactacoustic.com)