

IMPACT ACOUSTIC®

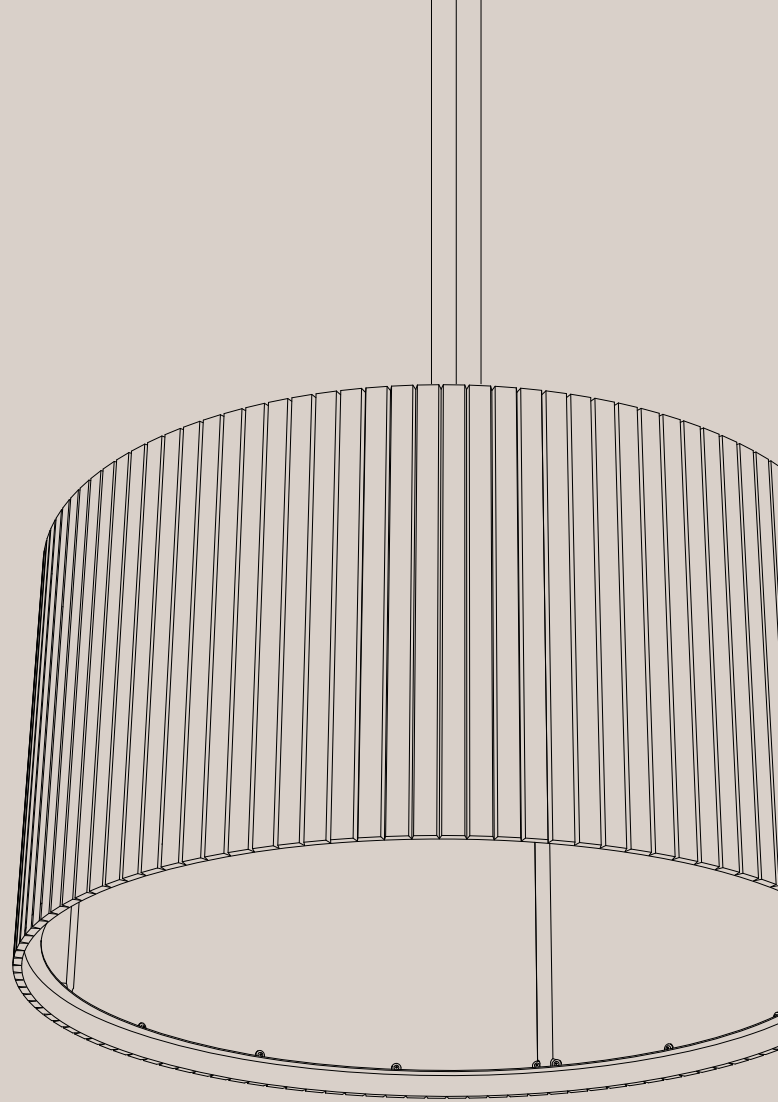

Umbra Round Retrofit E26/E27 Acoustic Lighting

622.13.14.000.00
622.13.15.000.00
622.13.16.000.00
622.13.17.000.00
622.13.18.000.00

622.13.14.000.00A
622.13.15.000.00A
622.13.16.000.00A
622.13.17.000.00A
622.13.18.000.00A

TECHNICAL DATA SHEET

Umbra Round Retrofit E26/E27

Acoustic Lighting

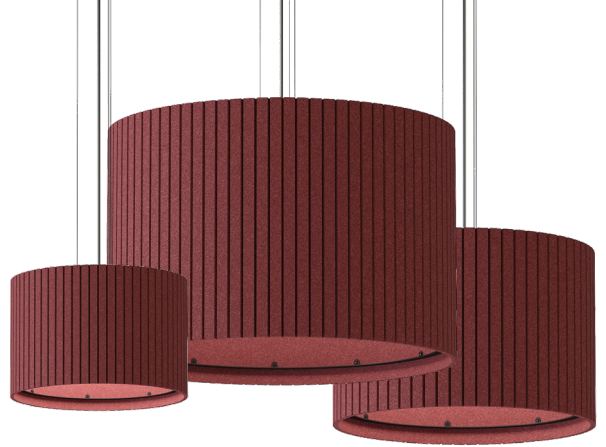

PRODUCT DIMENSIONS

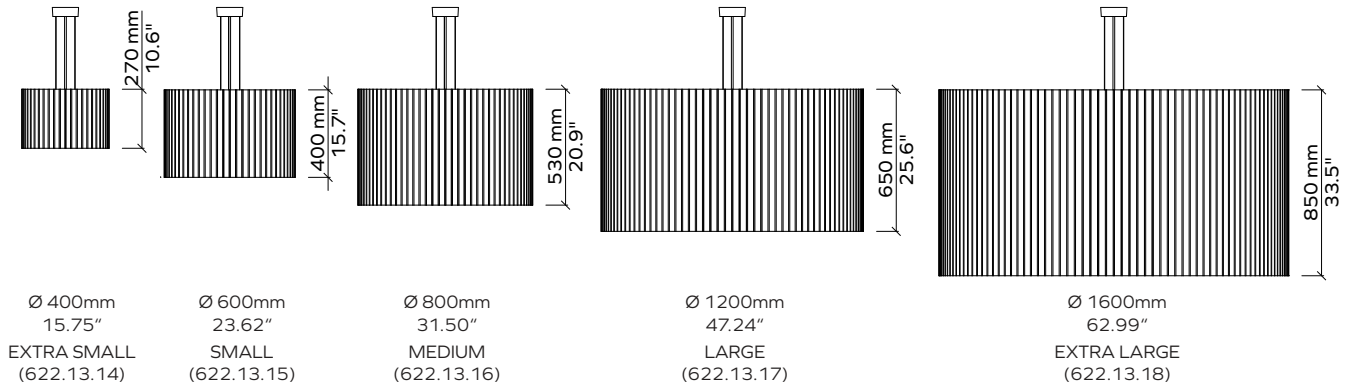

ARTICLE NUMBERS

Lighting product	Size of the product	Colour code	Market Voltages
622.13.	14. (Extra Small)	Choose color as shown on pg. 3	Standard Voltages (220 - 240 V) A for USA Market (110 - 277 V)
	15. (Small)		
	16. (Medium)		
	17. (Large)		
	18. (Extra Large)		

Example 1: 622.12.14.706.00A

Umbra Extra small [(400x270mm / 15.75"x10.6", Spearmint 706 color, E26 Bulb (USA & Canada))

Example 2: 622.12.17.706.00

Umbra Large [(1200x650mm / 47.24x25.6", Spearmint 706 color, E27 Bulb (EU))

SPECIFICATIONS

Specifications	For all sizes (622.12.)	
Wattage Max	20W (LED light bulbs only)	
Voltage	110 V - USA	220 V GLOBAL
Lampholder	1x E26	1x E27
Bulb not Included		

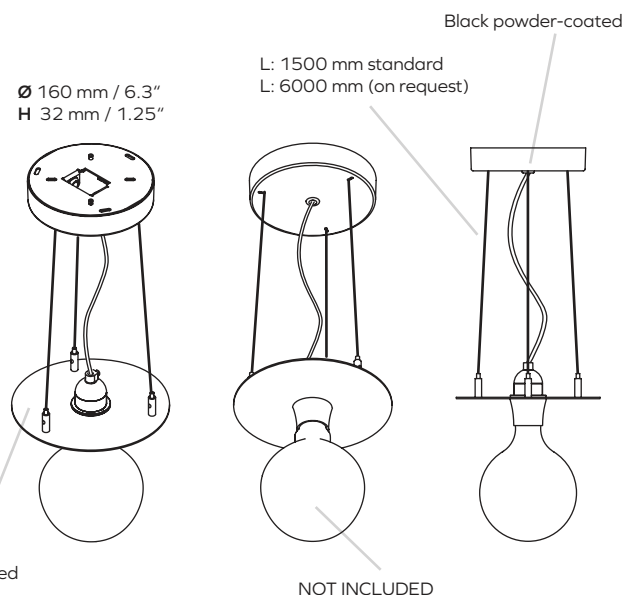











CERTIFICATIONS











ARCHISONIC® Felt Colors

 Material brochure available

									
Name	Snow White	Milk	Cloud	Gull	Smoke	Ground	Charcoal	Slate	Raven
Code	500	404	103	144	442	108	542	444	550
NCS	S 0300-N	S 0502-Y	S 1002-B	S 2502-Y	S 3005-R80B	S 5005-Y20R	S 7502-B	S 4500-N	S 8500-N

									
Name	Nordic Pine	Grove	Fern	Moss	Spearmint	Ice Blue	Succulent	Deep Sea	True Navy
Code	311	317	180	439	706	304	712	918	194
NCS	S 5030-G10Y	S 7020-G30Y	S 6010-G90Y	S 2040-G40Y	S 1010-B90G	S 0510-B	S 3020-B30G	S 5020-R90B	S 8005-B

									
Name	Lichen	Linen	Shell Pink	Jute	Warm Stone	Terracotta	Soft Coral	Honeycomb	Sunshine
Code	160	107	102	920	105	239	516	139	846
NCS	S 4005-Y	S 1505-Y30R	S 0510-R30B	S 3010-Y30R	S 3010-Y50R	S 4040-Y70R	S 2020-Y90R	S 2050-Y20R	S 1040-Y10R

									
Name	Garnet	Hot Pink	Poster Red	Electric Orange	Winter Sky	Pacific Ocean	Midnight	Grape	Marine Blue
Code	724	140	662	464	410	432	810	540	864
NCS	S 5040-R10B	S 2060-R20B	S 1080-R	S 0580-Y70R	S 2020-R90 B	S 3040-B	S 7020-R70B	S 5040-R40B	S 4050-R70B

These NCS codes are the closest visual match available and may not be exact to blended fibres.

ARCHISONIC®

Colors

Experience our ARCHISONIC® Felt material with a stunning selection of 36 colors across 8 distinct families, thoughtfully curated by *Colour Hive* in London. Effortlessly combine colors harmoniously to suit your preferences. Discover more in our Materials brochure and order your free sample box today.

Color fastness

Class 6

ISO 105-B02:A1

Order a free sample box



Umbra Round Retrofit E26/E27

Acoustic Performance



Testing Standards

ISO 354:2003	Acoustics — Measurement of sound absorption in a reverberation room
ISO 11654:1997	Acoustics — Sound absorbers for use in buildings — Rating of sound absorption
ISO 20189:2018	Acoustics — Screens, furniture and single objects intended for interior use — Rating of sound absorption and sound reduction of elements based on laboratory measurements
ASTM C423-17	Standard Test Method for Sound Absorption and Sound Absorption Coefficients by the Reverberation Room Method
ASTM E795-16	Standard Practices for Mounting Test Specimens During Sound Absorption Tests

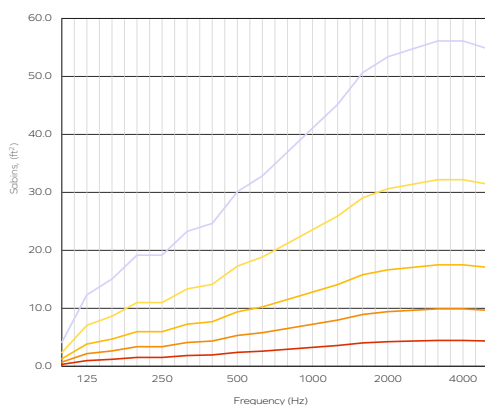

Acoustic Performance - ASTM Sabins, ft²

Frequency (Hz)	125	250	500	1000	2000	4000
12mm Umbra Round (Extra Small)	1.08	2.15	2.15	3.23	4.31	4.31
12mm Umbra Round (Small)	2.15	3.23	5.38	7.53	9.69	9.69
12mm Umbra Round (Medium)	3.23	6.46	8.61	12.92	16.15	17.22
12mm Umbra Round (Large)	6.46	11.84	17.22	23.68	30.14	32.29
12mm Umbra Round (Extra Large)	10.76	20.45	29.06	40.90	52.74	55.97

The graph represents the Sabins (ft²) in the third octave band center frequencies in accordance with ASTM C423.

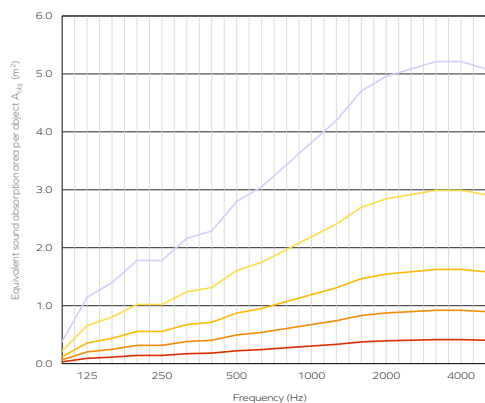

Acoustic Performance - ISO A_{obj}, m²

Frequency (Hz)	125	250	500	1000	2000	4000
12mm Umbra Round (Extra Small)	0.1	0.2	0.2	0.3	0.4	0.4
12mm Umbra Round (Small)	0.2	0.3	0.5	0.7	0.9	0.9
12mm Umbra Round (Medium)	0.3	0.6	0.8	1.2	1.5	1.6
12mm Umbra Round (Large)	0.6	1.1	1.6	2.2	2.8	3.0
12mm Umbra Round (Extra Large)	1.0	1.9	2.7	3.8	4.9	5.2

The graph represents the equivalent sound absorption per object (A_{obj}) in the third octave band center frequencies in accordance with ISO 20189. Measurement used Pink Noise as excitation signal in a reverberant room.

- 12mm Umbra Round (Extra Small)
- 12mm Umbra Round (Small)
- 12mm Umbra Round (Medium)
- 12mm Umbra Round (Large)
- 12mm Umbra Round (Extra Large)

ARCHISONIC® Felt

Material Specification

Product Name	Archisonic® Felt	
Content	100% PET (60% certified post-consumer content)	
Thickness¹	12mm (0.47")	24mm (0.94")
Max. Size	1200x2800mm (47"x110")	1800x2400mm (70"x94")
Acoustic²	ASTM: NRC=0.6 ISO: $\alpha_w=0.65$	ASTM: NRC=0.9 ISO: $\alpha_w=0.95$
Density¹	2400 g/m ² (0.49 lbs/ sqft)	4000 g/m ² (0.82 lbs/sqft)
Color Fastness	Class 6 ISO 105-B02:A1	
Color	36 colors (see Archisonic® Felt Color page for more information)	
Maintenance	For daily cleaning we recommend alcohol solution (75%), e.g. Pantasept. In case of contamination by dust or fluff, use feather duster or a regular vacuum cleaner. For heavy dirt, treat the material with hydrogen peroxide.	
Production Lead time³	21 days	
Fire Rating	DIN EN 13501-1: B-s1, d0	ASTM E84 Class A
VOC Emission	28 Days French Regulation A+ ASTM E84 Pass Bream® (International, UK, NL, SE, NOR) Exemplary CDPH (CDPH/EHLB/Standard Method V1.2) Pass	
Certifications	Declare label, Cradle to Cradle, UL Environmental Product Declaration, Member of US Green Building Council, Ecobau 1st Priority, Climmate-KIC, VOC emissions in LEED EQ credit (low-emitting products), SCS Recycled Content	
Durability	Contract	

1 - all values are nominal 2 - measured with 300mm air cavity 3 - depending on the location and type of product



Climate-KIC is supported by the EIT, a body of the European Union



Declare.



Umbra Round Retrofit E26/E27

Acoustic Lighting

Online Resources

A variety of resources are available online for all of our products. Please visit the product's page for more information.



CAD files
IES/LDT files



Spec sheets and
Installation Guide



Color families



Instruction
videos



Associated
products specs.

Ordering Process

Our experienced team of Project Consultants will guide and support you throughout the order process. We fulfill the majority of our orders in as little as 21 days¹ from your first point of contact, allowing you to focus on what truly matters to you.



Contact our
consultant

Quote¹

48 h



Order Confirmation

Production¹

2 - 3 weeks



Dispatch

Transit

location based



Delivery

Contact Us

Ready to make an impact? We are just an email or call away to discuss your project and answer any question.



+41 41 244 14 00



connect@impactacoustic.com



Online form

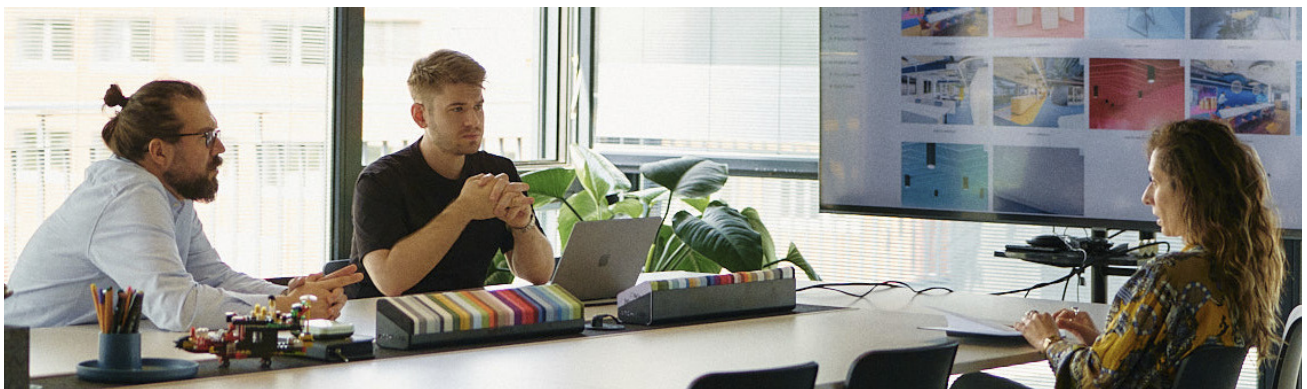

¹ - Quote and Production times may vary.

IMPACT ACOUSTIC®
Umbra Round Acoustic Lighting rev.01 - 26.05.25

(Switzerland)
(USA)
(Philippines)

connect@impactacoustic.com
usa@impactacoustic.com
philippines@impactacoustic.com

(+41) 41 566 55 55
(+1) 646 918 1581
(+63) 285 80 02 50

#WeMakeAnImpact

**#We
Make An
Impact**

connect@impactacoustic.com | www.impactacoustic.com