

IMPACT ACOUSTIC®

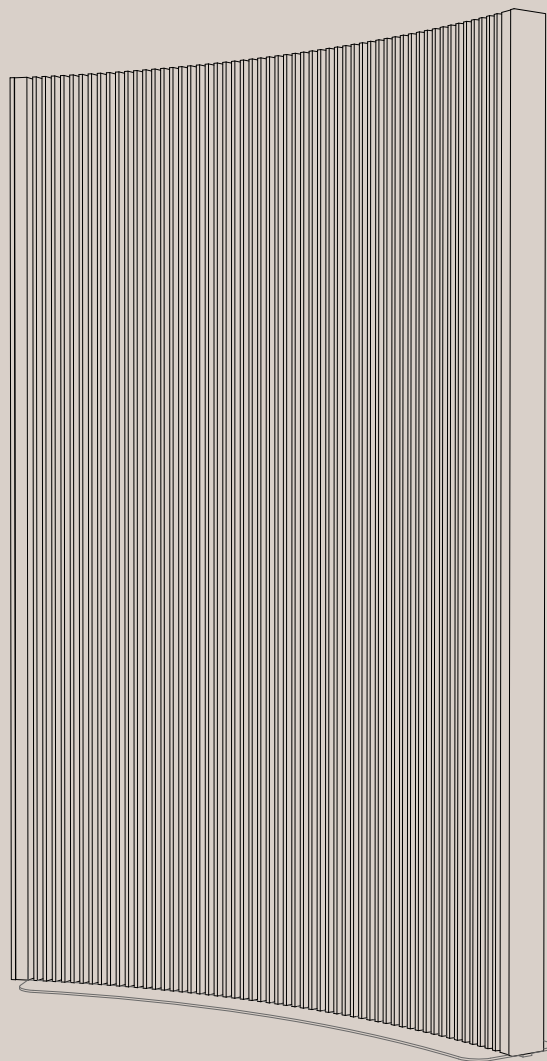

# Omnia

## Standing Partition

742.24.70.000.00

TECHNICAL DATA SHEET

# Omnia

## Standing Partition

### Article Number

742.24.70.000.00

### Dimensions

|           |        |        |
|-----------|--------|--------|
| Length    | 1174mm | 46.22" |
| Width     | 1810mm | 71.25" |
| Thickness | 285mm  | 11.22" |

### Information

1 pc., incl. installation kit

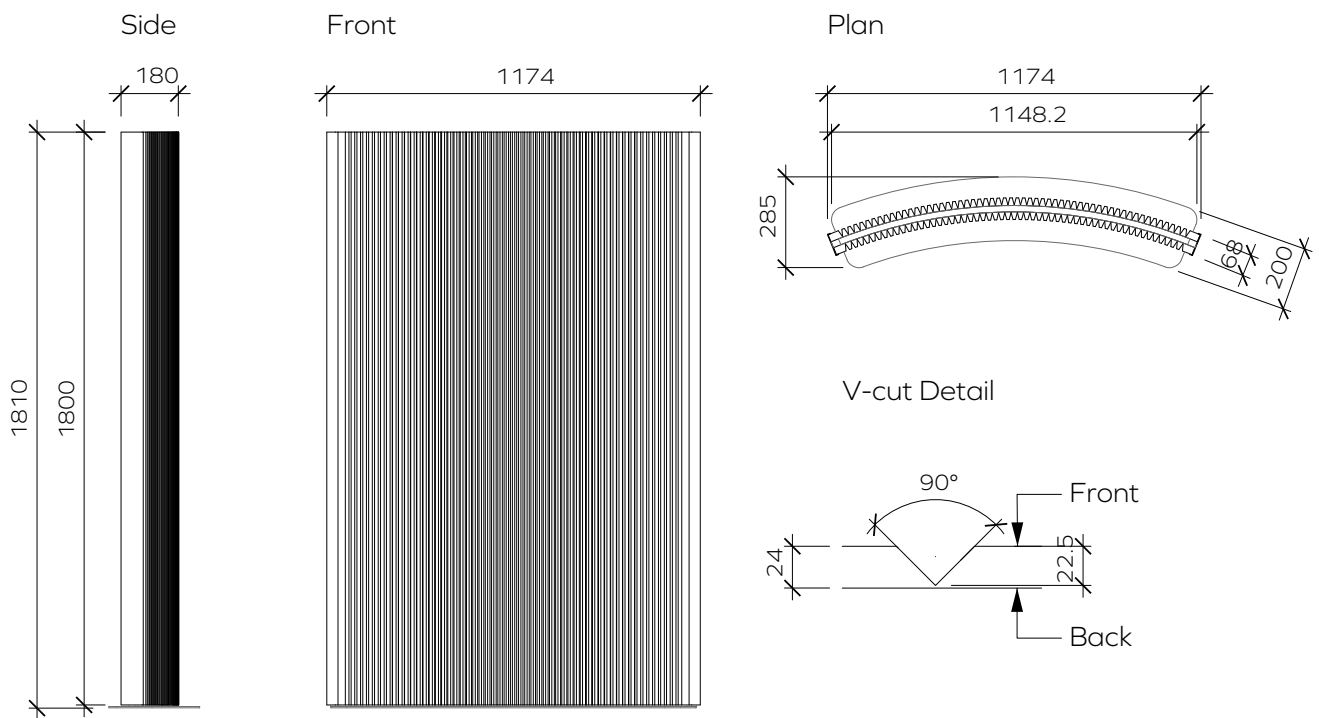
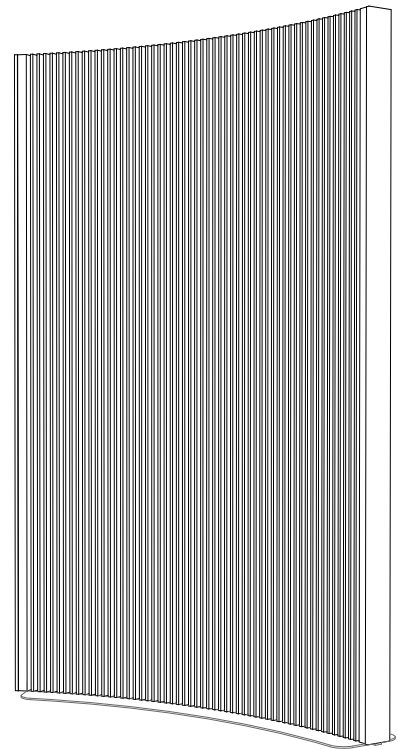

# ARCHISONIC®

## Colours

### Quiet Neutrals

12mm & 24 mm

These shades work in harmony with natural textural materials and soften industrial environments. From light to dark and cool to warm, these are the foundations of any scheme where longevity and a mood of calm is desired.



Snow White  
500



Cloud  
103



Smoke  
442



Ground  
108

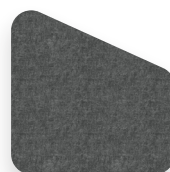

Charcoal  
542



Slate  
444



Raven  
550

### Warm Naturals

12mm & 24 mm

Combinations of lighter toned neutrals and pinks have a gently soothing and restorative effect while the more saturated hues make perfect environments for relaxation.



Warm Stone  
105



Milk  
404



Shell Pink  
102



Soft Coral  
516



Terracotta  
239



Garnet  
724

# ARCHISONIC®

## Colours

### Living Greens

12mm & 24 mm

From the cool greens of forests to the yellowed aspect of young wheat, we see Living Greens breathing life into indoor spaces, and an essential palette for the future. Use in tonal layers brings the depth and diversity of green, while a single note can provide an amplifying backdrop to a biophilic space.

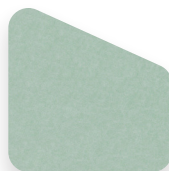

Spearmint  
706



Succulent  
712



Moss  
439



Nordic Pine  
311



Grove  
317

### Elemental Blues

12mm & 24 mm

These blues work perfectly both as familiar single hues and in effortless tonal layers to create an immersive environment for focus or restoration.



Ice Blue  
304



Winter Sky  
410



Marine Blue  
864



Pacific Ocean  
432



Midnight  
810

# ARCHISONIC®

## Colours

### Soothing Pastels

12mm & 24 mm

With tonal duos of pink and blue and green, this perfectly balanced group is designed for peaceful plays on light and shade and playful contrast. While the lightest tones have a dreamlike quality, their deeper counterparts add a subtle grounding.



Shell Pink  
102

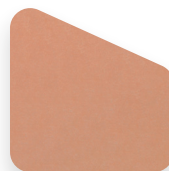

Soft Coral  
516



Ice Blue  
304



Winter Sky  
410

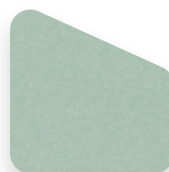

Spearmint  
706



Succulent  
712

### Elegant Darks

12mm & 24 mm

While colour can create a mood, it is the depth or lightness of a hue that truly defines the emotion. While each hue has the strength to stand alone, beautiful effects can be achieved with harmonized pairs.



Garnet  
724



Marine Blue  
864



Midnight  
810



Nordic Pine  
311



Raven  
550

# ARCHISONIC®

## Colours

### Energetic Brights

12mm & 24 mm

There are no rules here with endless possibilities for clashing contrasts or surprising highlights. For a sophisticated use of energetic colour, take a single hue and colour match contrasting textiles and solid surfaces.



Pacific Ocean  
**432**



Moss  
**439**



Sunshine  
**846**



Electric Orange  
**464**



Hot Pink  
**140**

### Primary Play

12mm & 24 mm

The primary story happens when all three main colours are used together, with varied proportions creating differing moods. As with the Energetic Brights palette, combine with coordinating-coloured textiles and solid surfaces.



Snow White  
**500**



Charcoal  
**542**



Sunshine  
**846**



Poster Red  
**662**



Marine Blue  
**864**

# ARCHISONIC® Material

## Composition

100% PET (60% certified post-consumer content)

## Material Reutilisation

**24mm**

88 PET bottles/m<sup>2</sup>

**12mm**

53 PET bottles/m<sup>2</sup>

## Density

**24mm**

4000 g/m<sup>2</sup> (+/-10%)

**12mm**

2400 g/m<sup>2</sup> (+/-10%)

## Dimensions Raw Panels

**24mm**

1800 x 2400 x 24mm

70" x 94" x 0.94" (+/-7%)

**12mm**

1200 x 2800 x 12mm

47" x 110" x 0.47" (+/-7%)

## Fire Test

**B-s1, d0**

DIN EN 13501-1

**Class A**

ASTM E84

## VOC Emission

**A+**

28 Days French Regulation

**Pass**

14 Days CDPH/EHLB



## Care Instructions

PET fibres do not provide a breeding ground for bacteria and other germs. The dyed-through fibres do not bleach out even when using aggressive cleaning agents and disinfectants. Alcohols, aldehydes or active chlorine can be used for cleaning.

For daily cleaning we recommend alcohol solution (75%), e.g. Pantasept. In case of contamination by dust or fluff, use feather duster or a regular vacuum cleaner. For heavy dirt, treat the material with hydrogen peroxide.

# Declare.

**ARCHISONIC®  
Impact Acoustic AG**

**Final Assembly:** Lucerne, Switzerland

**Life Expectancy:** 30 Year(s)

**End of Life Options:** Salvageable/Reusable in its Entirety, Take Back Program, Recyclable (98.5%)

**Ingredients:**

**PET:** Polyethylene Terephthalate; **Phosphorus flame retardant:** Phosphorus; **N, N'-Ethylene bis(stearamide):** Octadecanamide, N,N'-1,2-ethanedilylbis-; **Stearic acid:** Stearic Acid; **Titanium dioxide:** Titanium dioxide

**Living Building Challenge Criteria:** Compliant

**I-13 Red List:**

LBC Red List Free % Disclosed: 100% at 100ppm  
 LBC Red List Approved VOC Content: Not Applicable  
 Declared

**I-10 Interior Performance:** CDPH Standard Method v1.2-2017

**I-14 Responsible Sourcing:** Not Applicable

IMA-0001  
EXP. 01 AUG 2023  
Original Issue Date: 2022

MANUFACTURER RESPONSIBLE FOR LABEL ACCURACY  
INTERNATIONAL LIVING FUTURE INSTITUTE™ [living-future.org/declare](https://living-future.org/declare)

# ARCHISONIC®

## Material

### Matching NCS Colour Codes

Developed by Colour Hive

|                   |                    |                    |                    |                    |                    |                    |                 |
|-------------------|--------------------|--------------------|--------------------|--------------------|--------------------|--------------------|-----------------|
| Quiet Neutrals    | 500                | 103                | 442                | 108                | 542                | 444                | 550             |
| NCS Code          | <b>S 0300-N</b>    | <b>S 1002-B</b>    | <b>S 3005-R80B</b> | <b>S 5005-Y20R</b> | <b>S 7502-B</b>    | <b>S 4500-N</b>    | <b>S 8500-N</b> |
| Warm Naturals     | 105                | 404                | 102                | 516                | 239                | 724                |                 |
| NCS Code          | <b>S 3010-Y50R</b> | <b>S 0502-Y</b>    | <b>S 0510-R30B</b> | <b>S 2020-Y90R</b> | <b>S 4040-Y70R</b> | <b>S 5040-R10B</b> |                 |
| Living Greens     | 706                | 712                | 439                | 311                | 317                |                    |                 |
| NCS Code          | <b>S 1010-B90G</b> | <b>S 3020-B30G</b> | <b>S 2040-G40Y</b> | <b>S 5030-G10Y</b> | <b>S 7020-G30Y</b> |                    |                 |
| Elemental Blues   | 304                | 410                | 864                | 432                | 810                |                    |                 |
| NCS Code          | <b>S 0510-B</b>    | <b>S 2020-R90B</b> | <b>S 4050-R70B</b> | <b>S 3040-B</b>    | <b>S 7020-R70B</b> |                    |                 |
| Soothing Pastels  | 102                | 516                | 304                | 410                | 706                | 712                |                 |
| NCS Code          | <b>S 0510-R30B</b> | <b>S 2020-Y90R</b> | <b>S 0510-B</b>    | <b>S 2020-R90B</b> | <b>S 1010-B90G</b> | <b>S 3020-B30G</b> |                 |
| Elegant Darks     | 724                | 846                | 810                | 311                | 550                |                    |                 |
| NCS Code          | <b>S 5040-R10B</b> | <b>S 4050-R70B</b> | <b>S 7020-R70B</b> | <b>S 5030-G10Y</b> | <b>S 8500-N</b>    |                    |                 |
| Energetic Brights | 432                | 439                | 846                | 464                | 140                | 540                |                 |
| NCS Code          | <b>S 3040-B</b>    | <b>S 2040-G40Y</b> | <b>S 1040-Y10R</b> | <b>S 0580-Y70R</b> | <b>S 2060-R20B</b> | <b>S 5040-R40B</b> |                 |
| Primary Play      | 500                | 542                | 846                | 662                | 864                |                    |                 |
| NCS Code          | <b>S 0300-N</b>    | <b>S 7502-B</b>    | <b>S 1040-Y10R</b> | <b>S 1080-R</b>    | <b>S 4050-R70B</b> |                    |                 |

These NCS codes are the closest visual match available and may not be exact to blended fibres.

### Colour fastness

#### Class 6

ISO 105-B02:A1

### Colour and surface deviation

ARCHISONIC® is manufactured to the highest quality standards, but slight colour and surface variations caused by the high percentage of recycled fibers are an unavoidable part of the product characteristics and do not claim warranty. Please request a free sample box to verify the colours.

# ARCHISONIC® Material

## Light Reflection

Hochschule Luzern – Institut für Gebäudetechnik | Energie

**HSLU** Hochschule  
Luzern

|                   |              |              |              |              |              |              |             |
|-------------------|--------------|--------------|--------------|--------------|--------------|--------------|-------------|
| Quiet Neutrals    | 500          | 103          | 442          | 108          | 542          | 444          | 550         |
| Reflectance p     | <b>61.9%</b> | <b>51.4%</b> | <b>34.6%</b> | <b>22.5%</b> | <b>6% 1</b>  | <b>7.9%</b>  | <b>2.6%</b> |
| Warm Naturals     | 105          | 404          | 102          | 516          | 239          | 724          |             |
| Reflectance p     | <b>27.5%</b> | <b>59.3%</b> | <b>55.2%</b> | <b>34.1%</b> | <b>10.3%</b> | <b>4.1%</b>  |             |
| Living Greens     | 706          | 712          | 439          | 311          | 317          |              |             |
| Reflectance p     | <b>51.7%</b> | <b>27.7%</b> | <b>33.2%</b> | <b>10.3%</b> | <b>9.6%</b>  |              |             |
| Elemental Blues   | 304          | 410          | 864          | 432          | 810          |              |             |
| Reflectance p     | <b>60%</b>   | <b>32%</b>   | <b>9.5%</b>  | <b>15.2%</b> | <b>3.7%</b>  |              |             |
| Soothing Pastels  | 102          | 516          | 304          | 410          | 706          | 712          |             |
| Reflectance p     | <b>55.2%</b> | <b>34.1%</b> | <b>60%</b>   | <b>32%</b>   | <b>51.7%</b> | <b>27.7%</b> |             |
| Elegant Darks     | 724          | 846          | 810          | 311          | 550          |              |             |
| Reflectance p     | <b>4.1%</b>  | <b>9.7%</b>  | <b>3.7%</b>  | <b>10.3%</b> | <b>2.6%</b>  |              |             |
| Energetic Brights | 432          | 439          | 846          | 464          | 140          | 540          |             |
| Reflectance p     | <b>15.2%</b> | <b>33.2%</b> | <b>44.3%</b> | <b>26.8%</b> | <b>12.2%</b> | <b>5.5%</b>  |             |
| Primary Play      | 500          | 542          | 846          | 662          | 864          |              |             |
| Reflectance p     | <b>61.9%</b> | <b>6%</b>    | <b>44.3%</b> | <b>12.5%</b> | <b>9.5%</b>  |              |             |

## Sustainability



MINIMUM 60% RECYCLED CONTENT  
POST-CONSUMER

Supported by



Climate-KIC is supported by the  
EIT, a body of the European Union

**#We  
Make An  
Impact**

[connect@impactacoustic.com](mailto:connect@impactacoustic.com) | [www.impactacoustic.swiss](http://www.impactacoustic.swiss)