

IMPACT ACOUSTIC®

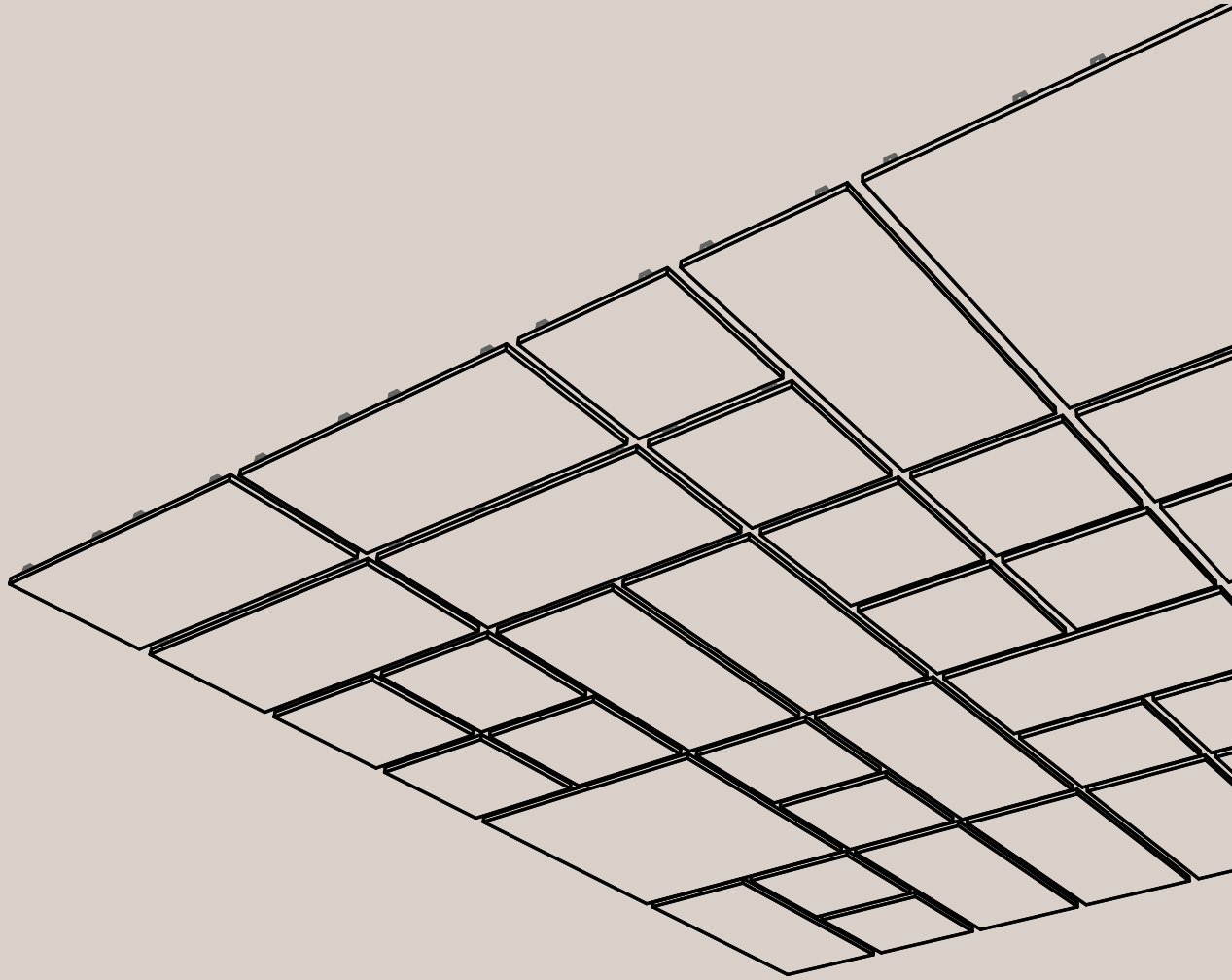

Piet

Ceiling Panel System

714.24.11.000.00
714.24.12.000.00
714.24.13.000.00

TECHNICAL DATA SHEET

Piet

General Information

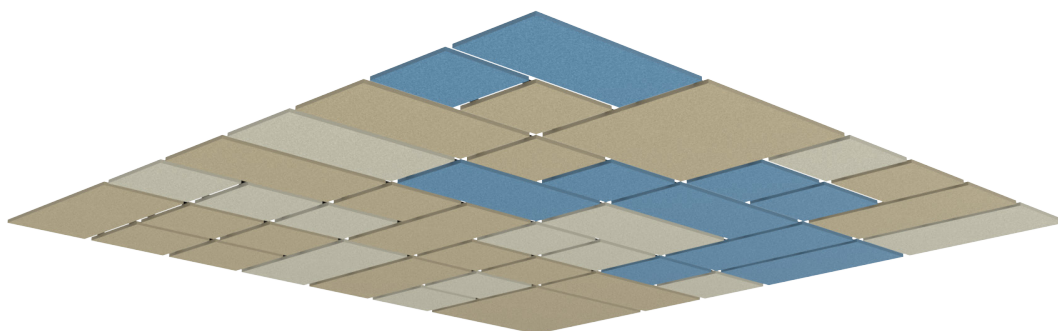

Data

Applicable article numbers

714.24.11.000.00
 714.24.12.000.00
 714.24.13.000.00

Dimensions¹

Tile Spacing	50mm	1.96"
Cluster Spacing	50mm	1.96"
Material thickness	24mm	0.94"

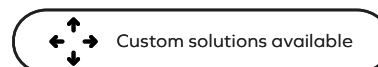

Material

Tiles 100% PET (60% post-consumer) in 32 colors.
 Strut profiles Steel (galvanized or powder coated black)

Weight²

Tiles	4kg/m ² (±10%)	0.82 lbs/ft ² (±10%)
Strut profile	0.62kg/m	0.99 lbs/ft

Included

Base Tiles

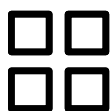

Suspension system⁴

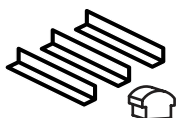

Installation guide



Design revision

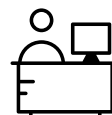

Warranty 2 years³



1 - all dimensions are nominal 2 - all weight values are nominal 3 - Impact Acoustic warranty terms apply 4 - Includes patented FeltFix System

Piet

Specification Guide

Ensure you make the perfect choice by choosing our solutions for your next project. To get started, simply define some basic information and constraints about your space. Then explore our range of standard solutions or contact us directly for a more in-depth discussion of personalised customized options.

1 Prepare this information:

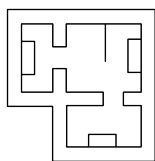

Project Area

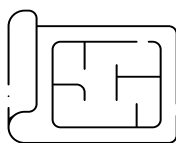

Ceiling Plans (RCP)

page 9



Other Considerations

page 9

2 Specify your design options:

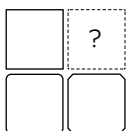

Corner Style

page 7

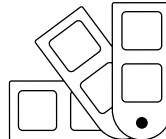

Color(s)

page 10

Geometry Information

Base Tiles

Piet is based on three different base tiles. The dimensions of these tiles evolved through a combination of optimizing material use, and generating scalable patterns. For these reasons the dimensions of the tiles are fixed. Piet's base tiles can easily be modified on site, please check our Installation Instructions manual for more information.

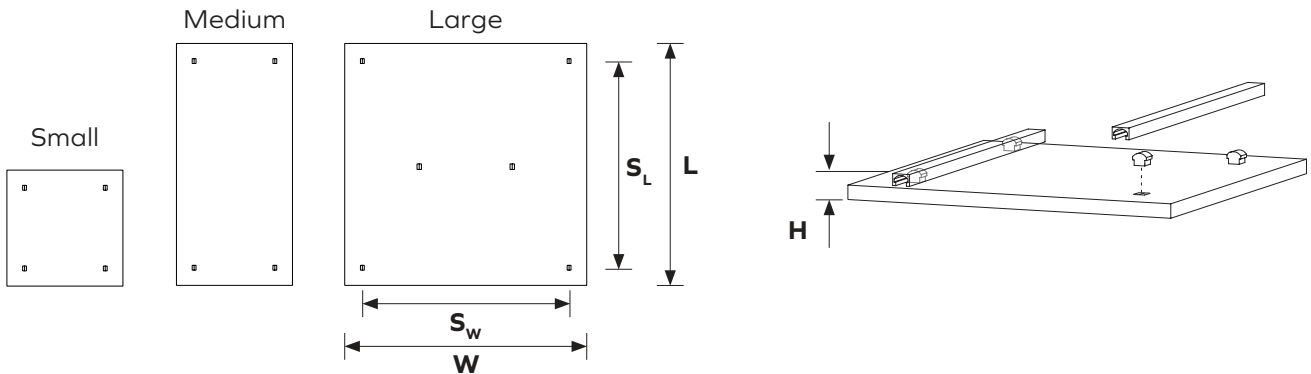

Dimension tables

Base Tiles		Small		Medium		Large	
L	Length	575mm	22.6"	1200mm	47.25"	1200mm	47.25"
W	Width	575mm	22.6"	575mm	22.6"	1200mm	47.25"
H	Height	47mm	1.85"	47mm	1.85"	47mm	1.85"
Sw	Suspension Width	400mm	15.75"	400mm	15.75"	1025mm	40.35"
Sl	Suspension Length	400mm	15.75"	1025mm	40.35"	1025mm	40.35"
Tp	Panel Thickness	24mm	0.95"	24mm	0.95"	24mm	0.95"

Tile Clusters

Piet's Base Tiles are organized in Tile Clusters. These Tile Clusters are stochastically arranged into a grid. The outer dimensions of these clusters and the gaps between tiles are fixed. All clusters have outer dimensions of 1200x1200mm (47.25in x 47.25in), and all gaps between the tiles within clusters are 50mm.

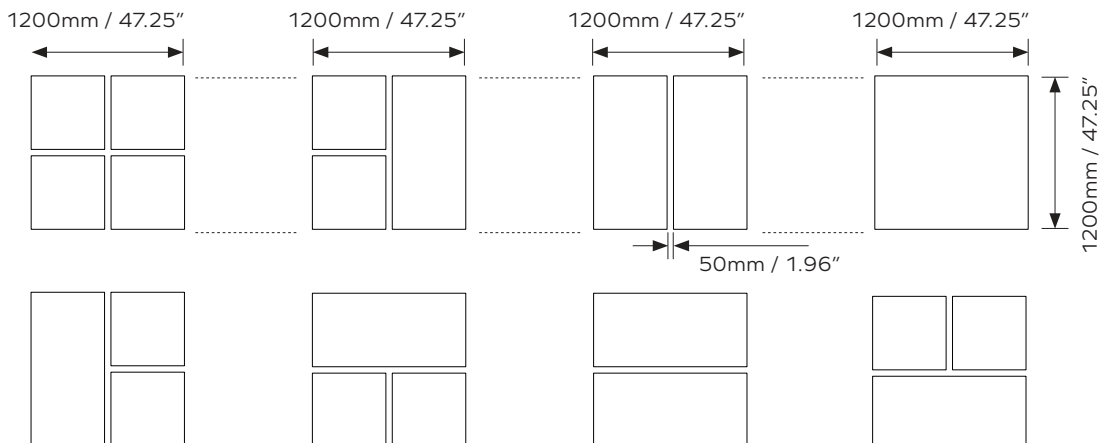

Geometry Information

Cluster Spacing

Cluster spacing (gap between tile clusters) is by default 50mm (1.96in). This is the same as the default spacing between tiles inside of clusters, which maintains a visual continuity. On request, the gap between clusters can be increased in the X, Y, or X and Y directions in order to accommodate lighting or other project-specific needs.

Default Gap (50mm - 1.96")

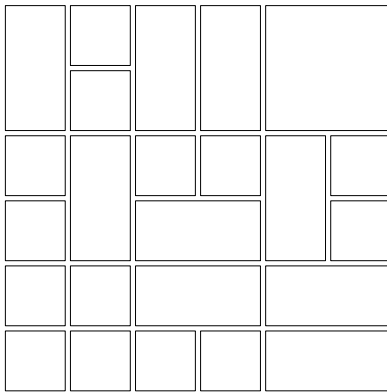

Custom Gap (X direction)

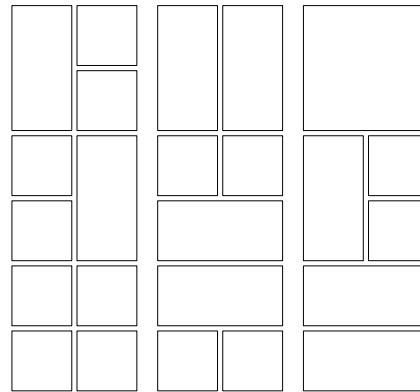

Custom gap (Y direction)

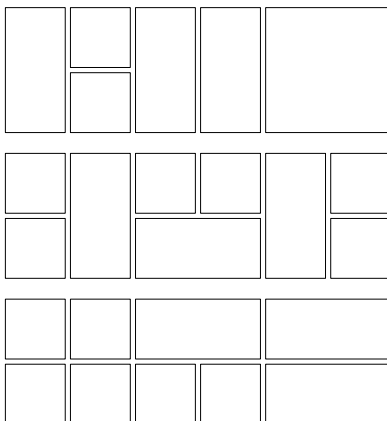

Custom gap (X and Y directions)

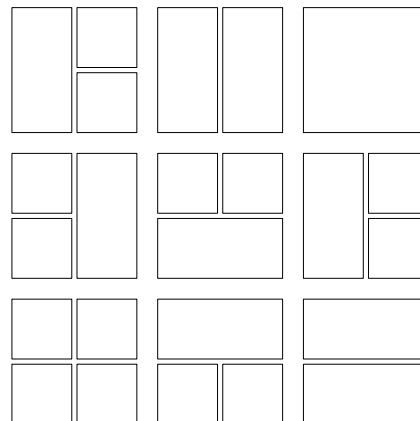

Geometry Information

Tiling Pattern and Color Variations

A near infinite number of tiling variations can be generated for any given Piet design. In addition to variations in the base tiling of the project, you can choose up to three colours. As with the initial generation of the tiling pattern, the shuffling of the colors is stochastically generated, and many variations can be created.

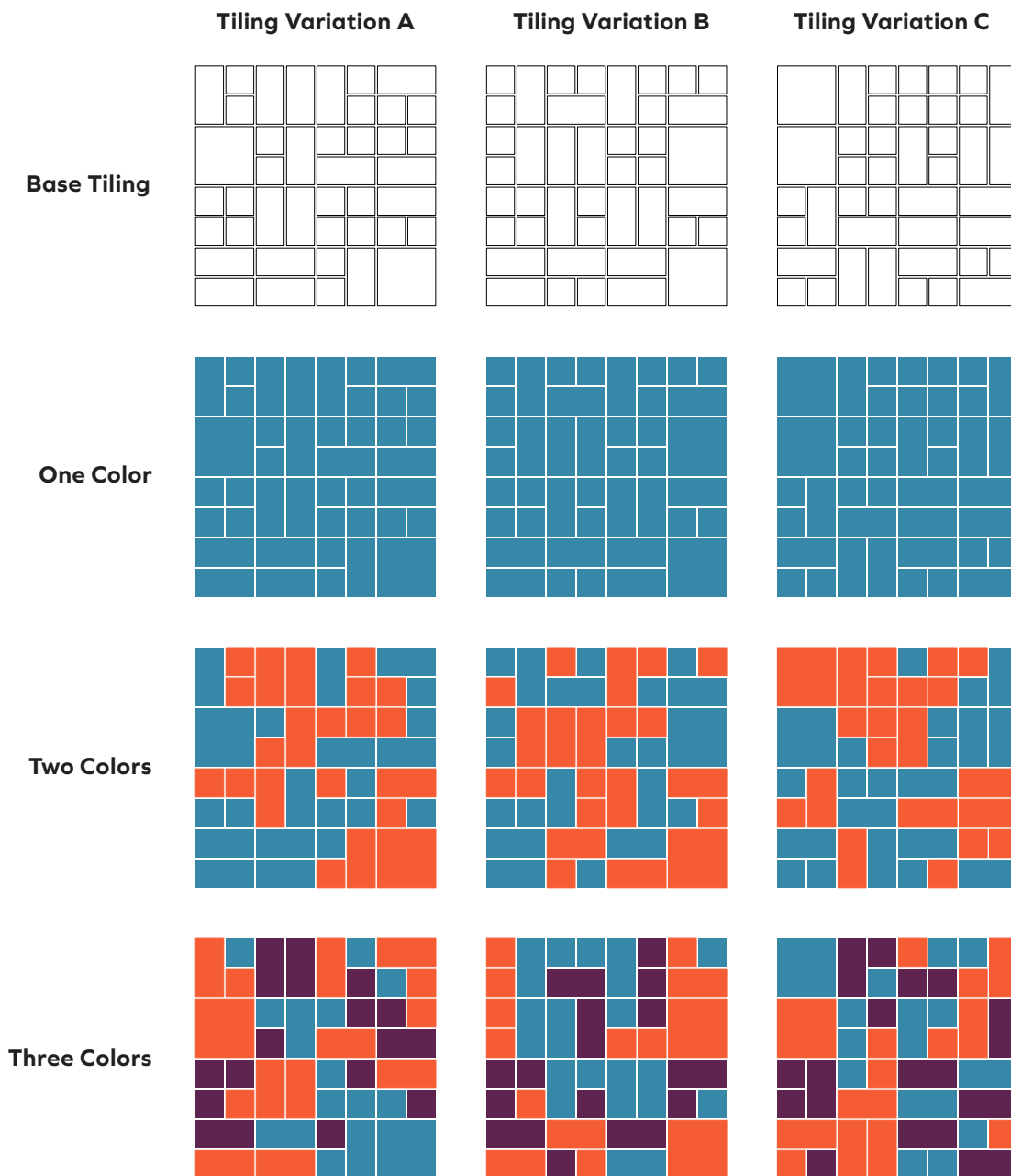

Geometry Information

Tile Corner Styles

Piet has three options for Tile Corner Styles: Straight, Fillet and Chamfer.

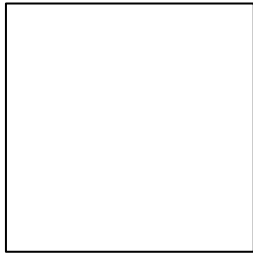

Straight

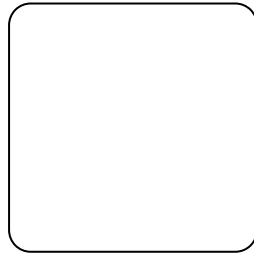

Fillet

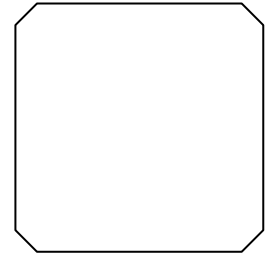

Chamfer

Dimensions:

- The fillet is set a default Radius of 50mm.
- The Chamfer is set at a Length of 50mm and an angle of 45°.
- Other dimensions are available upon demand.

Aesthetics

These corners can have a significant impact on the overall look of your project, giving you an additional tool to customize your installation even further.

Please see below examples of the three Corner Styles on an array of Tile Clusters:

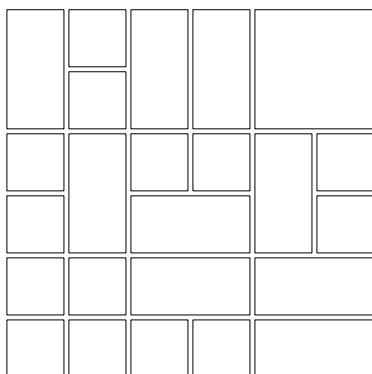

Straight

714.24.11.000.00

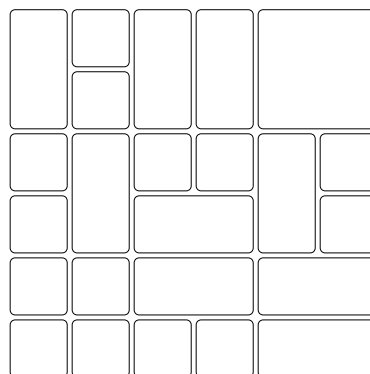

Fillet

714.24.12.000.00

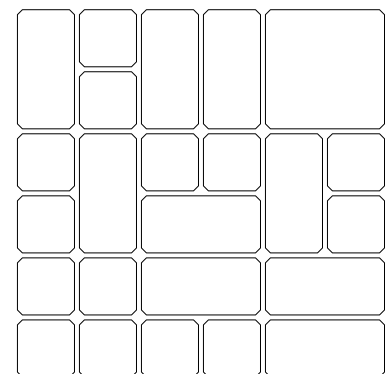

Chamfer

714.24.13.000.00

Piet

FeltFix System

Description

The FeltFix mount is a patented invention that we are offering as a mounting solution to some of our products. It consists of a small part made of Archisonic Felt 24mm that has been cut following a specific geometry so that it can be inserted into our Strut Channels.

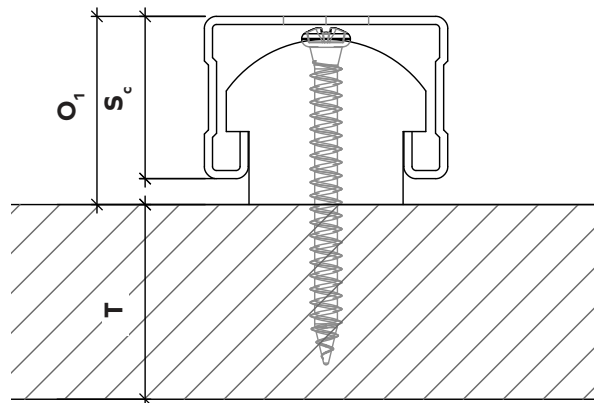
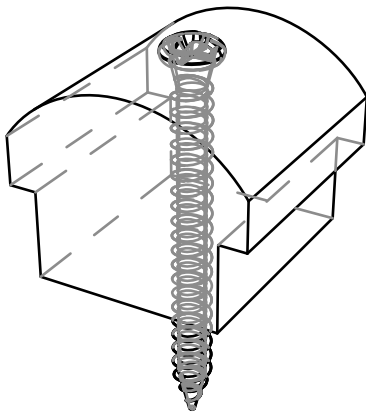

Dimensions table

S_c	Strut channel	20 mm	0.79"
O_1	Offset 1	23 mm	0.91"
T	Panel Thickness	24mm	0.96"

Key Features

Increased Circularity

- It is made from our left over material.
- Allows for the product to be taken down without taking any damage.
- The panels installed with this system could easily be relocated to a different space
- These panels also qualify for our take back program.

Optimized Installation

- Allows for less drilling points.
- More cost effective than standard mounting systems.
- Allows for adjustments once the product has been installed.
- Easy to adapt to panels that have been modified on site.



Installation Overview

1 Verify and Organize

Verify all delivered tiles and organize them based on the supplied drawings.

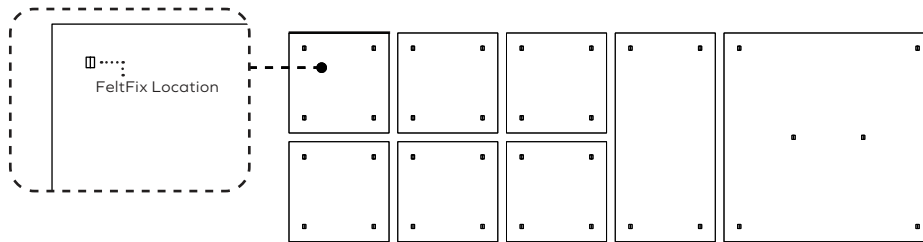

2 Piet Tile attached to Strut Channels

For the ceiling substructure we recommend using a suspension system for metal ceilings in combination with our Strut Channels. There are plenty of available options in the market. Here is an example: [METAL U-Profile from KNAUF Ceiling Solutions](#). Including following components:

- M300100 U-Profile
- M300119 Splice connector for U-Profile

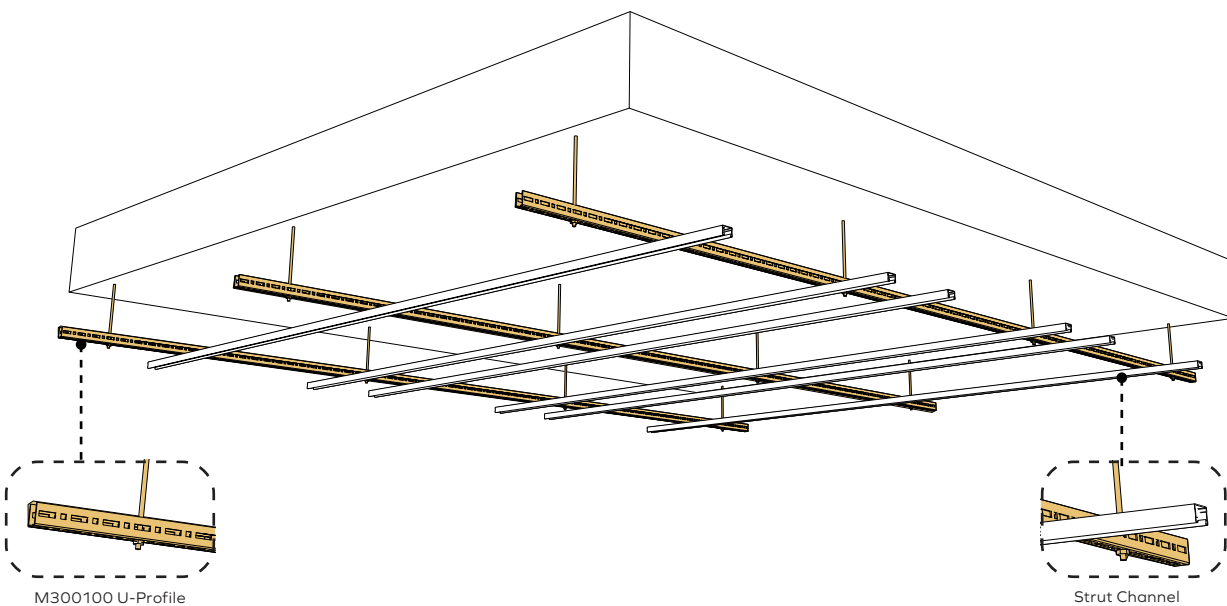

Installation Overview

3 On-site adjustments

Piet's base tiles can be adjusted on site using standard tools like a utility knife, a crown drill (hole saw) or a circular saw. The strut channels can also be trimmed using a power saw with a steel blade or an angle grinder.

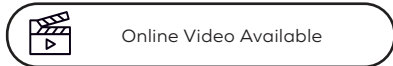
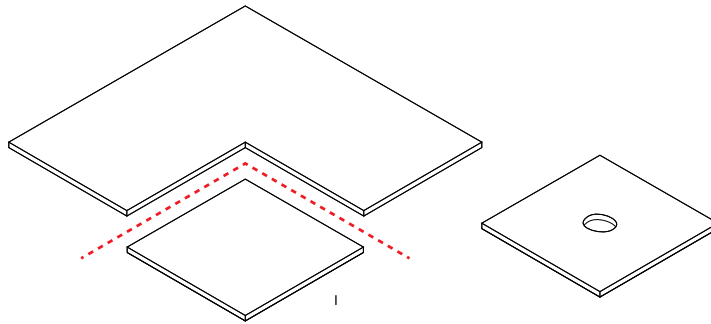
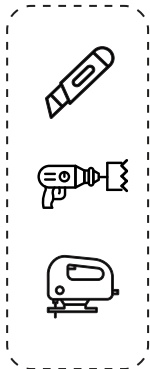

4 Install Felt Fix mounts and Base Tiles

Fix all the Felt Fix mounts to the tiles following the printed marks. Snap tiles into strut channels following the order on the supplied drawings and keeping the desired spacing between them. Repeat until it's done.

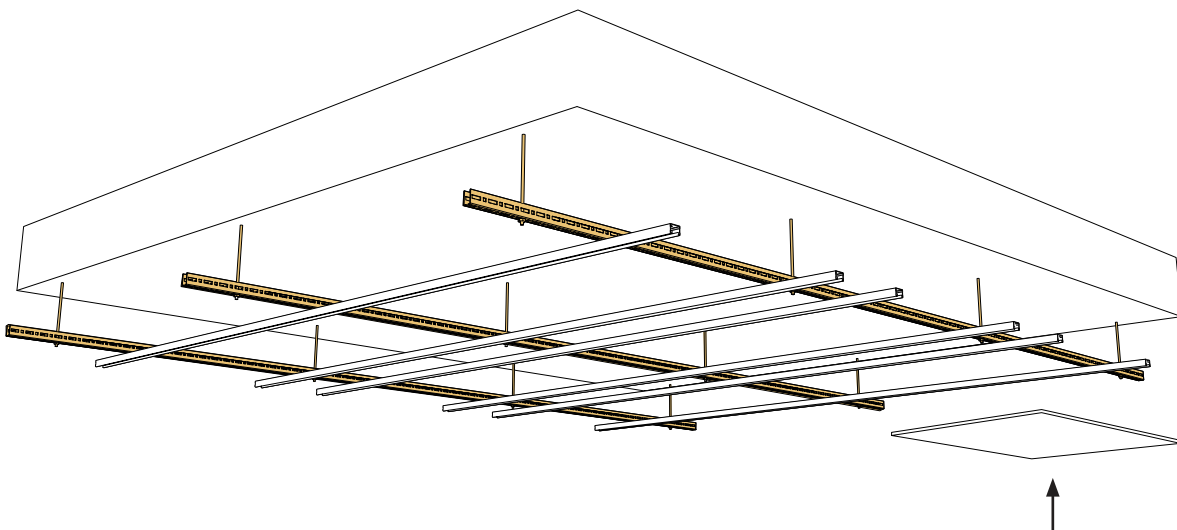
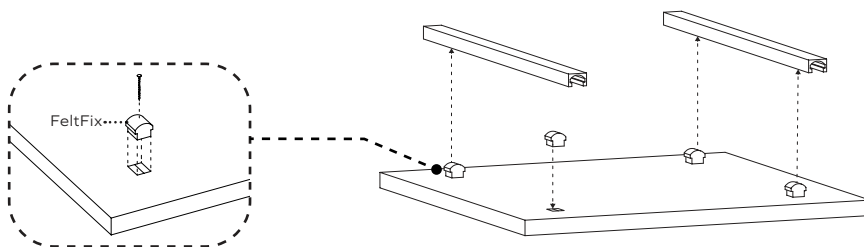

Planning Considerations

When planning the addition of a Piet Ceiling Tiling System to your space, please consider the following aspects.

1 Project Area

Check and verify the project area where the Ceiling Tiling System will be installed. This will allow us to provide you with an accurate quote.

2 Reverse Ceiling Plans

Verify if RCP drawings for the space are available. This will help plan for any obstacles like columns and air-ducts that might collide with the Tiles.

3 Additional considerations

Consider access to high windows and doors.

Verify the type of material to which the support elements will be mounted.

Plan for providing min. 100mm (4in) safe space distance from Tiles to other elements.

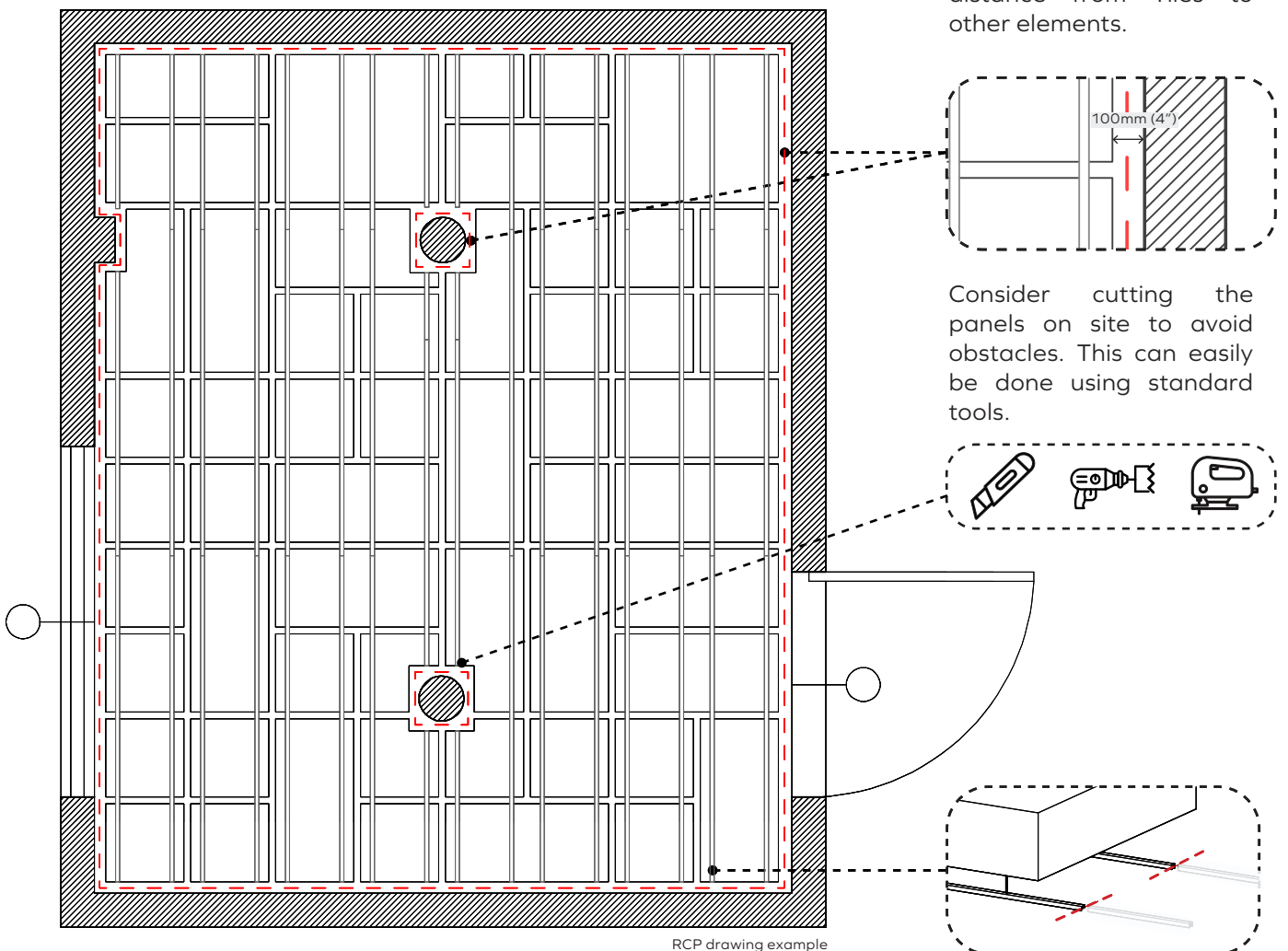











RCP drawing example

Consider cutting the panels on site to avoid obstacles. This can easily be done using standard tools.

The provided strut tracks might need to be cut to measure on site.









ARCHISONIC® Felt Colors

 Material brochure available

									
Name	Snow White	Milk	Cloud	Gull	Smoke	Ground	Charcoal	Slate	Raven
Code	500	404	103	144	442	108	542	444	550
NCS	S 0300-N	S 0502-Y	S 1002-B	S 2502-Y	S 3005-R80B	S 5005-Y20R	S 7502-B	S 4500-N	S 8500-N

									
Name	Nordic Pine	Grove	Fern	Moss	Spearmint	Ice Blue	Succulent	Deep Sea	True Navy
Code	311	317	180	439	706	304	712	918	194
NCS	S 5030-G10Y	S 7020-G30Y	S 6010-G90Y	S 2040-G40Y	S 1010-B90G	S 0510-B	S 3020-B30G	S 5020-R90B	S 8005-B

									
Name	Lichen	Linen	Shell Pink	Jute	Warm Stone	Terracotta	Soft Coral	Honeycomb	Sunshine
Code	160	107	102	920	105	239	516	139	846
NCS	S 4005-Y	S 1505-Y30R	S 0510-R30B	S 3010-Y30R	S 3010-Y50R	S 4040-Y70R	S 2020-Y90R	S 2050-Y20R	S 1040-Y10R

									
Name	Garnet	Hot Pink	Poster Red	Electric Orange	Winter Sky	Pacific Ocean	Midnight	Grape	Marine Blue
Code	724	140	662	464	410	432	810	540	864
NCS	S 5040-R10B	S 2060-R20B	S 1080-R	S 0580-Y70R	S 2020-R90 B	S 3040-B	S 7020-R70B	S 5040-R40B	S 4050-R70B

These NCS codes are the closest visual match available and may not be exact to blended fibres.

ARCHISONIC®

Colors

Experience our ARCHISONIC® Felt material with a stunning selection of 36 colors across 8 distinct families, thoughtfully curated by *Colour Hive* in London. Effortlessly combine colors harmoniously to suit your preferences. Discover more in our Materials brochure and order your free sample box today.

Color fastness

Class 6

ISO 105-B02:A1

Order a free sample box



Piet

Tender Text

Product Name	Piet Acoustic Ceiling Panel System	
Content	Archisonic Felt 24mm 100% PET (60% certified post-consumer content) Galvanized Steel Strut Channels	
Size (Area)	Bespoke	
Size (Base Tiles)	Small 575x575 mm (22.6"x22.6") Medium 575x1200 mm (22.6"x47.25") Large 1200x1200 mm (47.25"x 47.25")	
Density¹	4000 g/m ² (0.82 lbs/sqft)	
Acoustic²	EN ISO 354:2003: $\alpha_w=0.75$	ASTM C423-17: NRC=0.85
Colors and finishes	36 colors (see Archisonic® Felt Color page for more information)	
Fire Rating	DIN EN 13501-1: B-s1, d0	ASTM E84 Class A
Warranty & Support	2-Year warranty ⁴ . Design support (incl. 1x revision).	
Installation Method	Via patented FeltFix mounts combined with steel Strut Channels	
Maintenance	For daily cleaning we recommend alcohol solution (75%), e.g. Pantasept. In case of contamination by dust or fluff, use feather duster or a regular vacuum cleaner. For heavy dirt, treat the material with hydrogen peroxide.	
Other Certificates	Breeam® (International, UK, NL, SE, NOR) Exemplary , Declare label, Cradle to Cradle, UL Environmental Product Declaration, Member of US Green Building Council, Ecobau 1st Priority, Climmate-KIC, VOC emissions in LEED EQ credit (low-emitting products), SCS Recycled Content, 28 Days French Regulation A+ , CDPH (CDPH/EHLB/ Standard Method V1.2) Pass , ISO 105-B02:A Class 6 .	

1 - all values are nominal 2 - measured with 300mm air cavity



Climate-KIC is supported by the EIT, a body of the European Union



Declare.



Piet

Acoustic Performance



Testing Standards

ISO 354:2003	Acoustics — Measurement of sound absorption in a reverberation room
ISO 11654:1997	Acoustics — Sound absorbers for use in buildings — Rating of sound absorption
ISO 20189:2018	Acoustics — Screens, furniture and single objects intended for interior use — Rating of sound absorption and sound reduction of elements based on laboratory measurements
ASTM C423-17	Standard Test Method for Sound Absorption and Sound Absorption Coefficients by the Reverberation Room Method
ASTM E795-16	Standard Practices for Mounting Test Specimens During Sound Absorption Tests

The acoustic performance of these Ceiling Panel System has been calculated based on the test reports from our Ceiling Panel range. Both are made in Archisonic Felt 24mm and are suspended from the ceiling. It will be important to point out that results may vary depending on the offset from the panel to the ceiling. For this purpose we are using a standard of 200mm airgap.

Acoustic Test Results

	α_w	SAA	NRC
Piet Ceiling Panel System	0.75 (MH)	0.85	0.85

1 - Measured with 200mm airgap and open edges

The NRC rating is calculated as the average of the absorption coefficients measured at frequencies of 250Hz, 500Hz, 1000Hz and 2000Hz and round to the nearest 0.05. SAA rating is calculated as the average of the sound absorption coefficients of a material for the twelve one-third octave bands from 200Hz through 2500Hz and rounded off to the nearest 0.01.

Acoustic Performance - Practical Sound Absorption Coefficient, α_p

Frequency (Hz)	125	250	500	1000	2000	4000
Piet	α_p	0.05	0.45	0.85	1.00	1.00

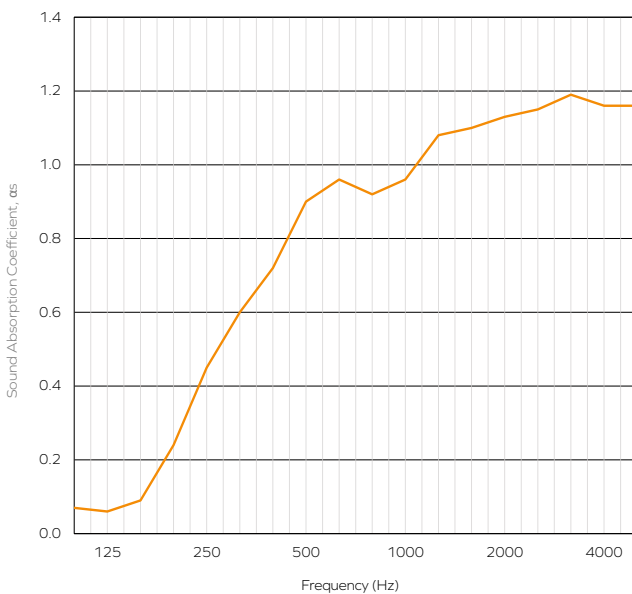

● Piet

The table represents the practical sound absorption coefficient (α_p) in accordance with ISO 11654. The graph represents the sound absorption coefficients (α_s) in the third octave band center frequencies in accordance with ISO 354. Measurement used Pink Noise as excitation signal in a reverberant room.

Piet

Reference Projects

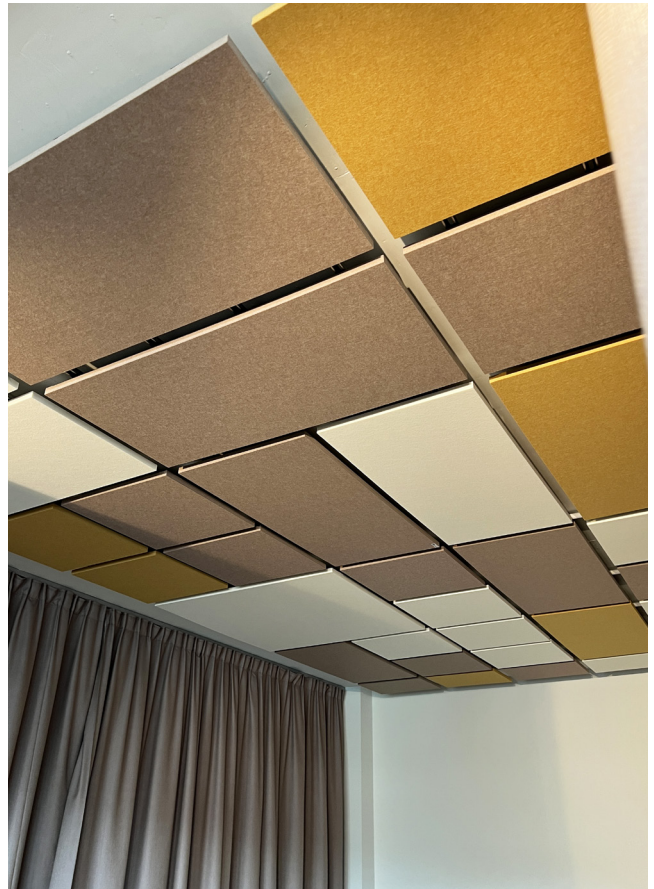

Piet

Additional Information

Online Resources

A variety of resources are available online for all of our products. Please visit the product's page for more information.



CAD files



Spec sheets and
Installation Guide



Color families



Instruction
videos



Associated
products specs.

Ordering Process

Our experienced team of Project Consultants will guide and support you throughout the order process. We fulfill the majority of our orders in as little as 21 days¹ from your first point of contact, allowing you to focus on what truly matters to you.



Contact our
consultant

Quote¹

48h



Order Confirmation

Production¹

14-21 days



Dispatch

Transit

location based



Delivery

Contact Us

Ready to make an impact? We are just an email or call away to discuss your project and answer any question.



+41 41 244 14 00



connect@impactacoustic.com



Online form

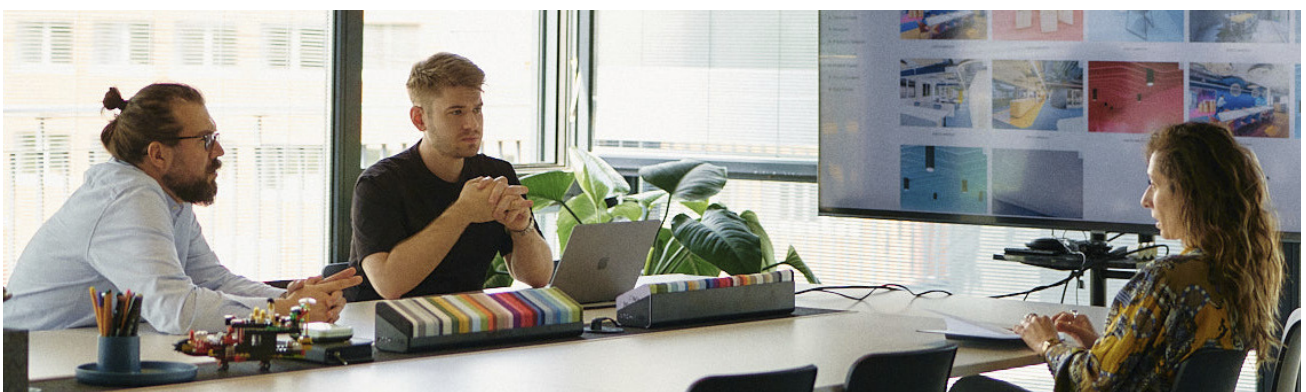

¹ - Quote and Production times may vary.

**#We
Make An
Impact**

connect@impactacoustic.com | www.impactacoustic.com