

IMPACT ACOUSTIC®



Rifteut

Wall Covering

734.12.10.000.00

TECHNICAL DATA SHEET

Riftcut Wall Covering

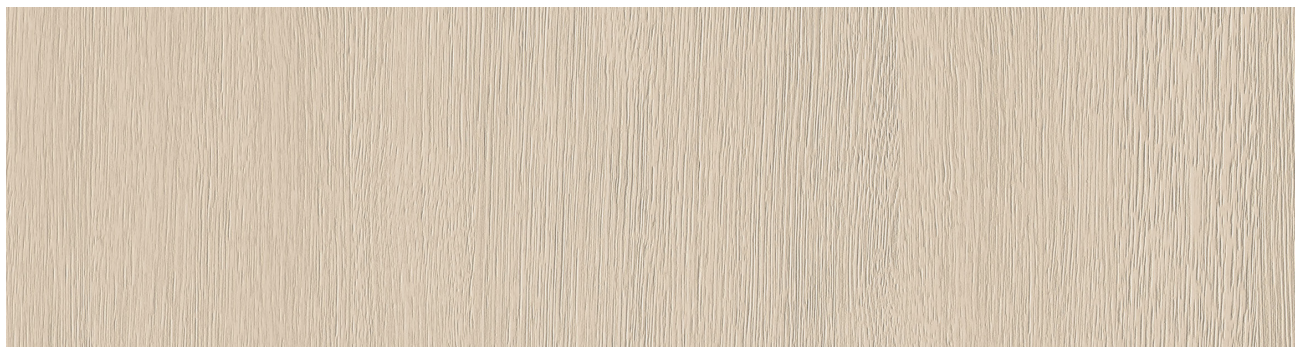

Data

Applicable article numbers

734.12.10.000.00

Total Dimensions³

Height	2800mm	110"
Width	1200mm	47"
Thickness	12mm	0.5"

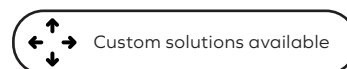

Material

Wall Covering 100% PET (60% post-consumer) in 33 printed texture hues

Weight¹

12mm / 0.47" 2.4 kg/m2 0.49 lbs/sq.ft

Included

PET Panels



Installation
guide



Warranty
2 years²



1 - all weights are nominal

2 - Impact Acoustic warranty terms apply

3 - all dimensions are nominal

Riftcut Wall Covering

Specification Guide

Ensure you make the perfect choice by choosing our solutions for your next project. To get started, simply define some basic information and constraints about your space. Then explore our range of standard solutions or contact us directly for a more in-depth discussion of personalised customized options.

1 Prepare this information:

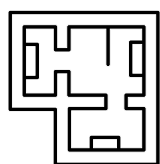

Project Area

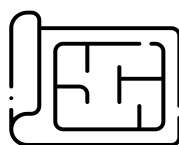

Plans



Other Considerations

2 Specify your Wall Covering:

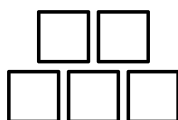

Quantity

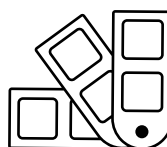

Colour

3 Mount type:

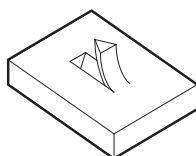

Undercover mount¹



Spray adhesive

4 Article numbers:

734	Material Thickness ²	10	Colour	Mount type
734	12mm	10	112	00

Example: 732.24.12.662.00

Riftcut Wall Covering, 2800 x 1200 x 12mm, 112 - Shadow 20, 00 - Undercover mount

1 - Patent Pending No.10202400009088

2 - all dimensions are nominal

Riftcut Wall Covering

Installation Methodes Overview

Undercover Mount (standard) *Patent Pending¹*

All our Wall Covering products come with pre-cut **Undercover** attachment points. Those points are distributed along the edge (10-15mm offset) of the panel. **Undercover** mounting system allows for concealed mechanical attachment of the panel to the mounting surface. The **installation hardware** (screws, bolts) needs to be selected in accordance to the surface on which panels are applied, and are **not included**.

1 Locate the Undercover cuts on the panel

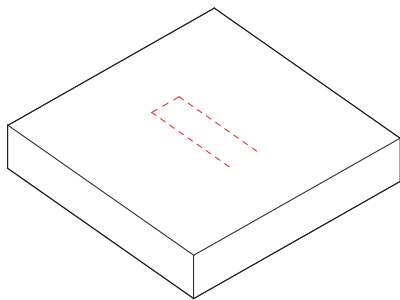

2 Pull out the edge

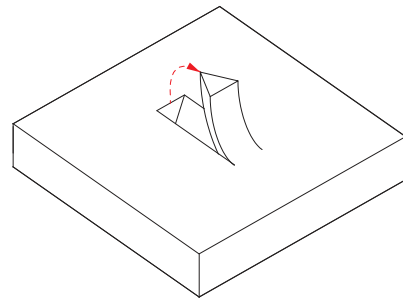

3 Install hardware

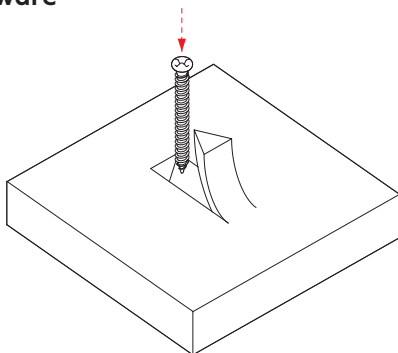

4 Close

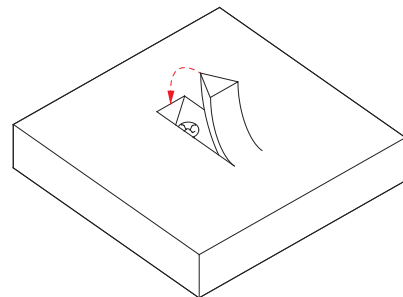

For full installation manual check our [product page](#).

Alternative methods

We offer **Spray Glue** as an alternative. For an advice on appropriate mounting method for your needs, please contact one of our Project Consultants.

Please note, that selected hardware for alternative installation methods is not included in a default delivery scope and needs to be accounted for separately.

1 - Patent Pending No.102024000009088

Riftcut Wall Covering

Geometry Information

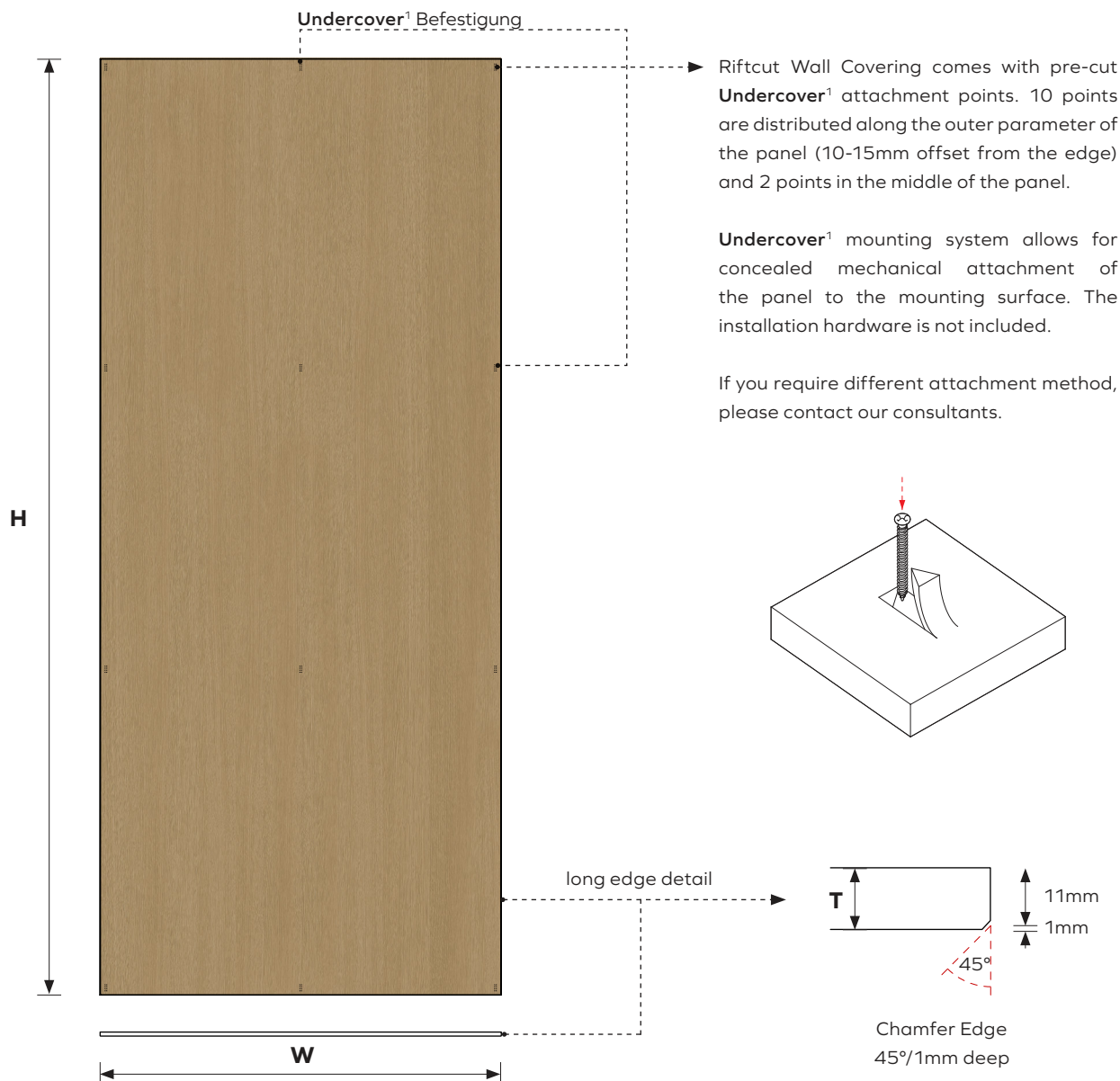

Dimensions table²

H	Height	2800mm	110"
W	Width	1200mm	47"
T	Thickness	12mm	0.5"

1 - Patent Pending No.10202400009088

2 - all dimensions are nominal

Riftcut Wall Covering

Installation Overview

For the best visual effect we recommend installing subsequent panels rotating them upside down, in a way, that every second panel is rotated. The long edge on a panel is chamfered with 1mm depth, fully printed with Riftcut texture.



1 - Patent Pending No.102024000009088

2 - all dimensions are nominal

IMPACT ACOUSTIC®
Riftcut Wall Covering rev.01 - 25.07.25

(Switzerland)
(USA)
(Philippines)

connect@impactacoustic.com
usa@impactacoustic.com
philippines@impactacoustic.com

(+41) 41 244 14 00
(+1) 646 918 1581
(+63) 285 80 02 50

#WeMakeAnImpact

ARCHISONIC® Riftcut

A Synthesis of Nature and Innovation

Developed in collaboration with German veneer specialists Schotten & Hansen and Swiss designer Ina Rinderknecht, ARCHISONIC® Riftcut adds a natural touch to our acclaimed Felt range.



ARCHISONIC® Riftcut Flax 50

Colour options

The printed shades form the basis of 24 colour spectrum, offering interior designers a sophisticated range of options linked to natural dyes.



Sustainable Ink

CP65 and RoHS3 compliant



Order a free sample set



ARCHISONIC® Riftcut Natural Collection

Natural Collection colour sets

Riftcut Natural Collection (NC) is a natural wood shade extension to our bestselling Riftcut. Developed in collaboration with German veneer specialists Schotten & Hansen, ARCHISONIC® Riftcut NC introduces 3 different colour groups: elegant brights, essential mids and classical darks.



ELEGANT BRIGHTS



240 Pebble

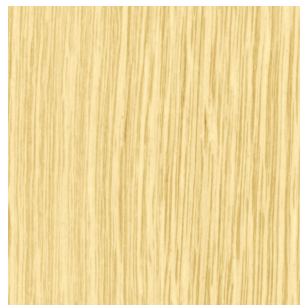

241 Sunlit



242 Blush



ESSENTIAL MIDS



243 Malt



244 Honey



245 Mocha



CLASSICAL DARKS



246 Woodsmoke



247 Bourbon



248 Twilight

Sustainable Ink

CP65 and RoHS3 compliant



Order a free sample set



ARCHISONIC® Felt (Printed option)

Material Specification

Product Name	ARCHISONIC® Felt	
Content	100% PET (60% certified post-consumer content)	
Thickness¹	12mm (0.47")	
Max. Size	1200x2800mm (47"x110")	
Acoustic^{2, 4}	ASTM: NRC=0.6 ISO: α_w =0.65	
Density¹	2400 g/m ² (0.49 lbs/ sqft)	
Colour	33 printed finishes.	
Maintenance	To prevent dust and stains, regularly dust or vacuum with a soft brush. Avoid tools that might scratch the surface. Use mild detergents sparingly for tough stains, blotting instead of rubbing with a microfiber cloth. Test cleaning methods on a hidden area first to check for adverse effects.	
Lead Time^{3, 4}	21 days	
Fire Rating⁴	DIN EN 13501-1: B-s1, d0	ASTM E84 Class A
VOC Emission⁴	28 Days French Regulation A+ ASTM E84 Pass Bream® (International, UK, NL, SE, NOR) Exemplary CDPH (CDPH/EHLB/Standard-Method V1.2) Pass	
Certifications⁴	Declare label, Cradle to Cradle, UL Environmental Product Declaration, Member of US Green Building Council, Ecobau 1st Priority, Climmate-KIC, VOC emissions in LEED EQ credit (low-emitting products), SCS Recycled Content	
Ink Certifications	UL Greenguard, No NVC, No VOCs, No TPO, Vegan, compliant with California Prop65 (CP65) and European Directive RoHS3	
Durability	Contract	

1 - all values are nominal 2 - measured with 300mm air cavity 3 - depending on the location and type of product



Riftcut Wall Covering

General Information

Online Resources

A variety of resources are available online for all of our products. Please visit the product's page for more information.



CAD files



Spec sheets and
Installation Guide



Colour families



Instruction
videos



Associated
products specs.

Ordering Process

Our experienced team of Project Consultants will guide and support you throughout the order process. We fulfill the majority of our orders in as little as 21 days¹ from your first point of contact, allowing you to focus on what truly matters to you.



Contact our
consultant

Quote¹

48h



Order Confirmation

Production¹

14-21 days



Dispatch

Transit

location based



Delivery

Contact Us

Ready to make an impact? We are just an email or call away to discuss your project and answer any question.



+41 41 244 14 00



connect@impactacoustic.com



Online form

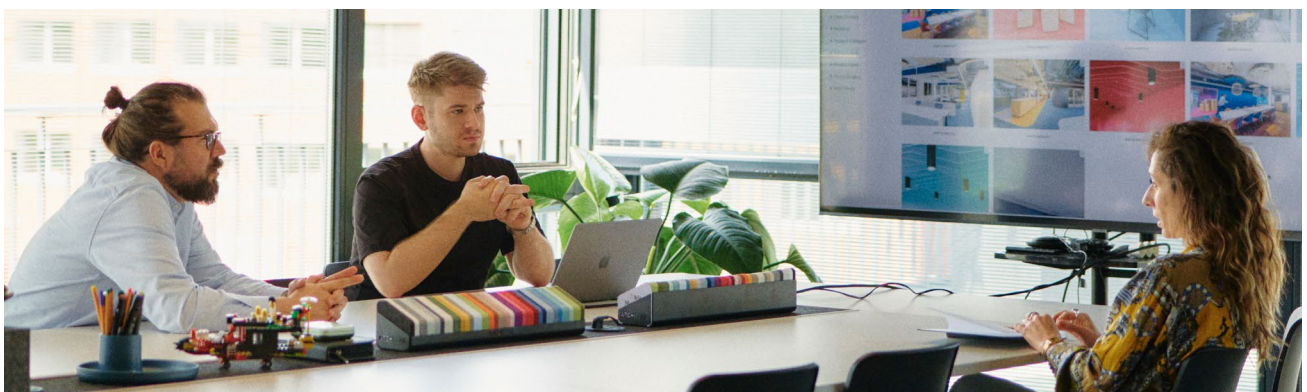

¹ - Quote and Production times may vary.

**#We
Make An
Impact**

connect@impactacoustic.com | www.impactacoustic.com