

IMPACT ACOUSTIC®

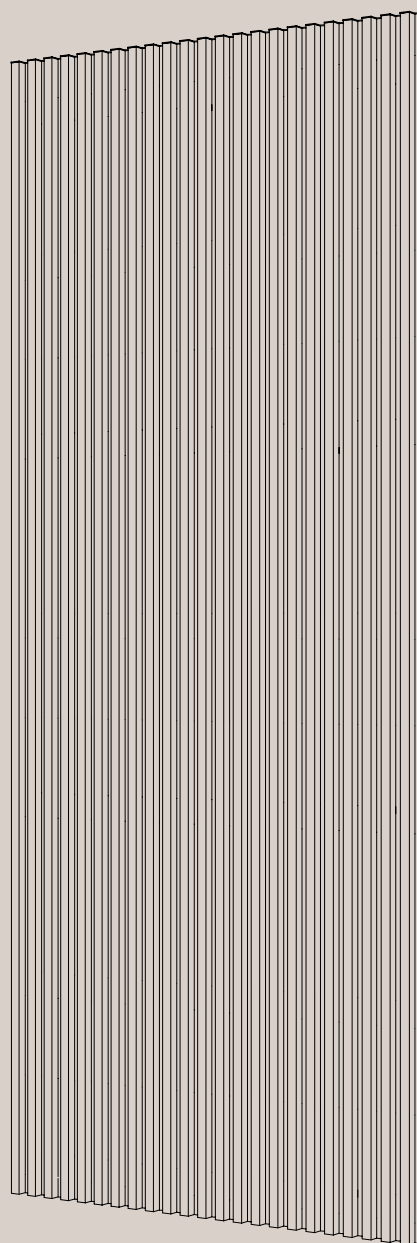

Track Wall Panels

735.12.10.000.00

735.12.11.000.00

735.12.12.000.00

735.12.13.000.00

Track Wall Panels

General Information

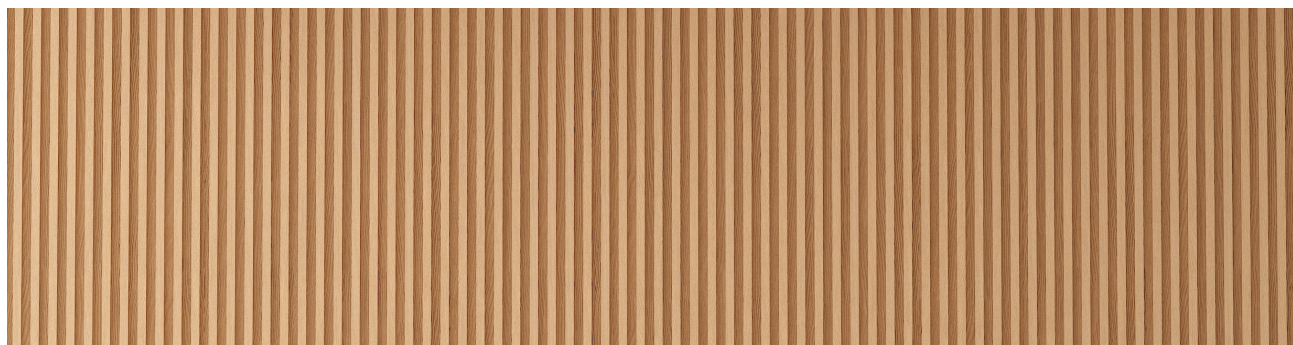

Data

Applicable article numbers

ARCHISONIC® Felt		ARCHISONIC® Riftcut	
735.12.10.000.00	735.12.11.000.00	735.12.12.000.00	735.12.13.000.00

Single element dimensions¹

Width	1200 mm	47"	
Height	2800 mm	110"	
Thickness	44 mm	1 3/4"	(without substructure)

Material

Panel	100% PET (60% post-consumer)
Substructure Profiles	Aluminum anodized black

Weight²

Panel	24kg (±10%)	53 lbs (±10%)	(without substructure)
Substructure Profiles	0.5kg (±10%)	1.1 lbs (±10%)	(weight of four profiles)

Included

Track Panels



Mounting
Z-Clip profiles
(pack of 7)

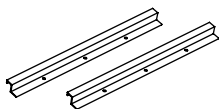

Endcaps 2x
(optional)

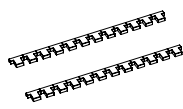

C00093

Installation
guide



Warranty
2 years³



1 - all dimensions are nominal 2 - all weight values are nominal

Track Wall Panels

Geometry Information¹

735.12.10.000.00 and 735.12.12.000.00 - Regular

FRONT

SIDE

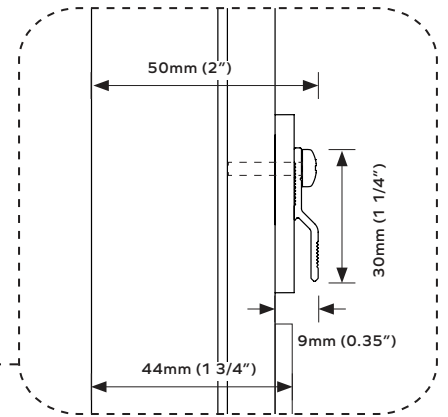
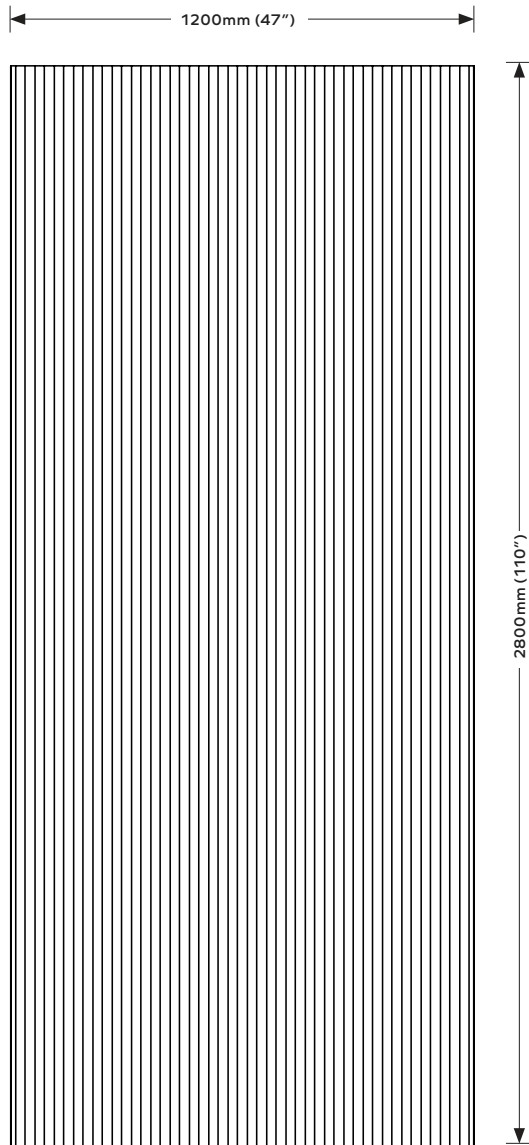

Z-Clip profile on the back of the panel. Z-Clip needs to be installed on top of the extension tabs.

TOP

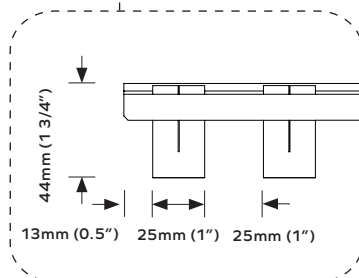

1 - all dimensions are nominal

Track Wall Panels

Geometry Information¹

735.12.11.000.00 and 735.13.12.000.00 - Edge

FRONT

SIDE

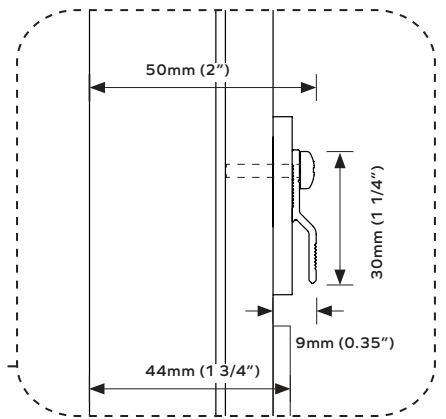
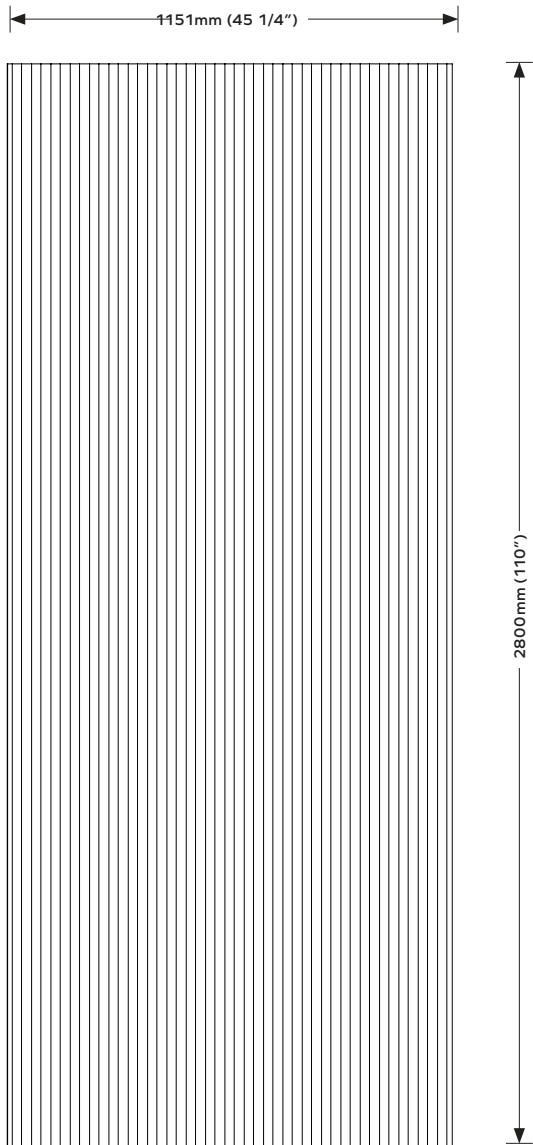

Z-Clip profile on the back of the panel. Z-Clip needs to be installed on top of the extension tabs.

TOP

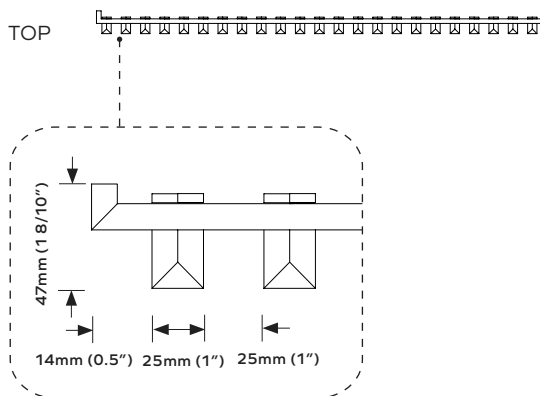

1 - all dimensions are nominal

Track Wall Panels

Product Family

Track panels are available as a product family of **1** Track Wall Panels and **2** Track Ceiling Panels.

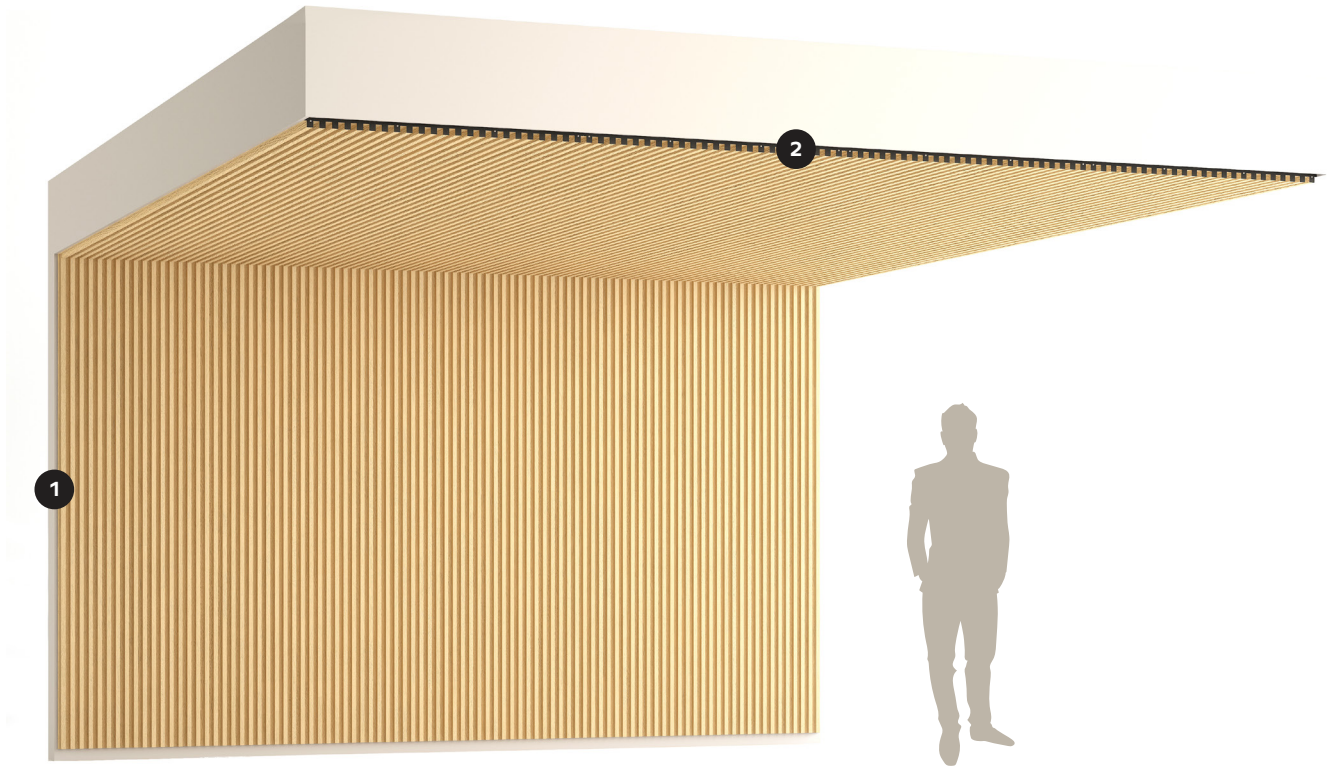

Track Wall Panels

Edge Treatment

1 Standard edge treatment (735.12.10.000.00, 735.12.12.000.00)

Raw white ARCHISONIC® Felt panel is exposed at the long edge of the panel ● When face joining consecutive panels in assembly the edge remains visible only at the last panel in a series.

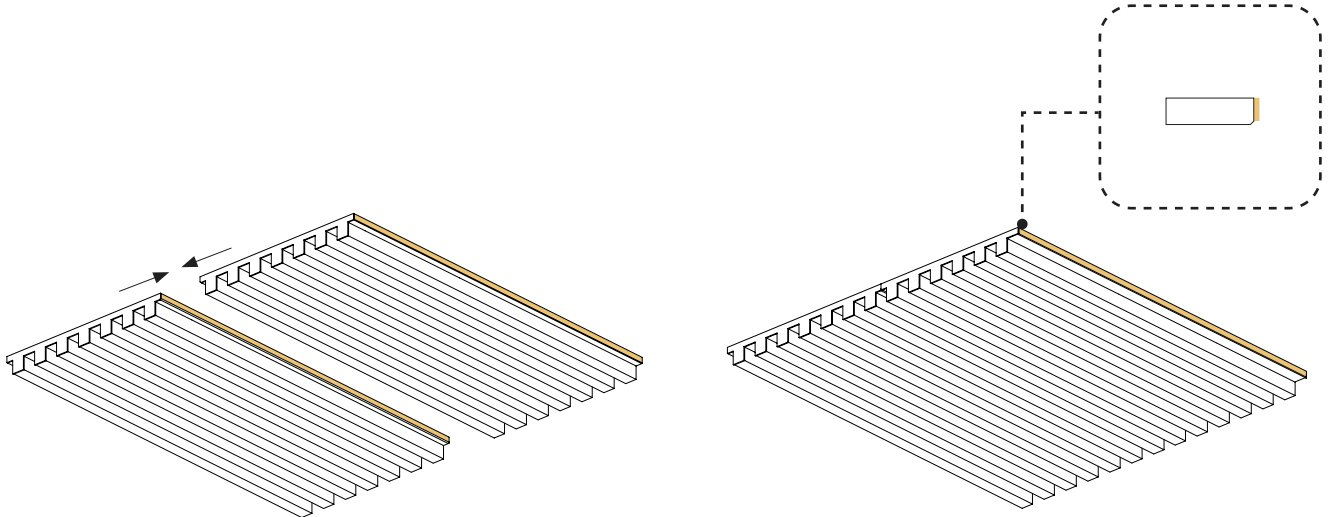

2 Flip-Edge treatment (735.12.11.000.00, 735.12.13.000.00)

If you require the last panel in the series to have concealed edge, without exposing the raw white ARCHISONIC® Felt colour ●, please request flip-edge edge treatment when contacting our consultants. Flip-Edge allows you to bend the panel edge upwards, hiding the exposed raw panel colour. The Flip-Edge can be glued on site using the hot glue gun.

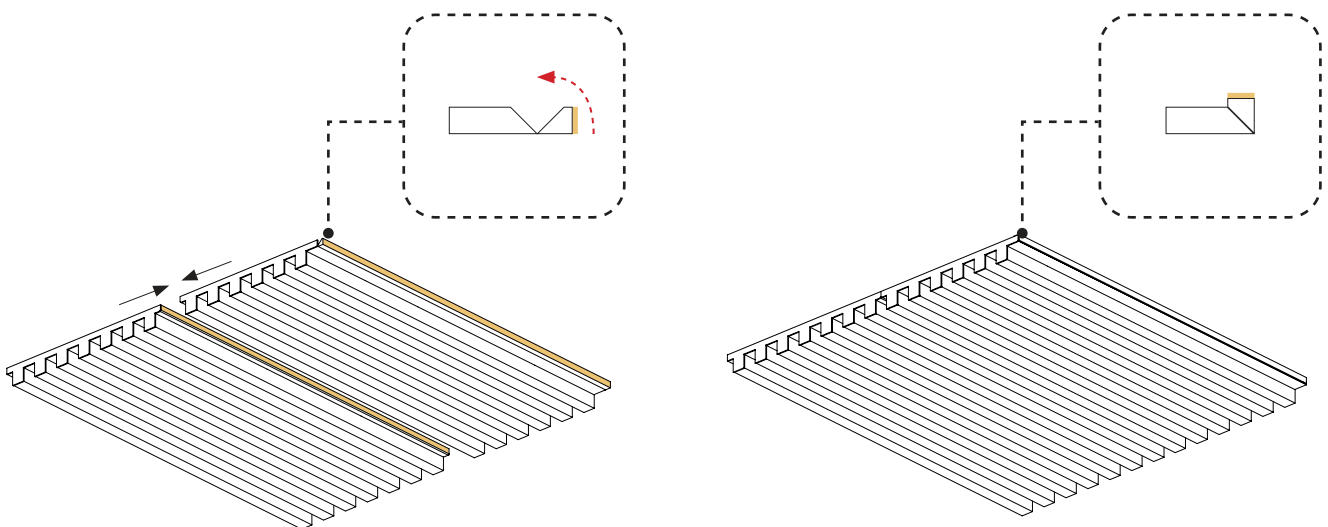

¹ all dimensions are nominal

Track Wall Panels

Assembly Overview

 Erweitertes Dokument verfügbar

1 On-Site adjustments.

Track base tiles can be adjusted on site using standard tools like a utility knife, a crown drill (hole saw) or a circular saw. The aluminum profiles can also be trimmed using a power saw with a steel blade or an angle grinder.

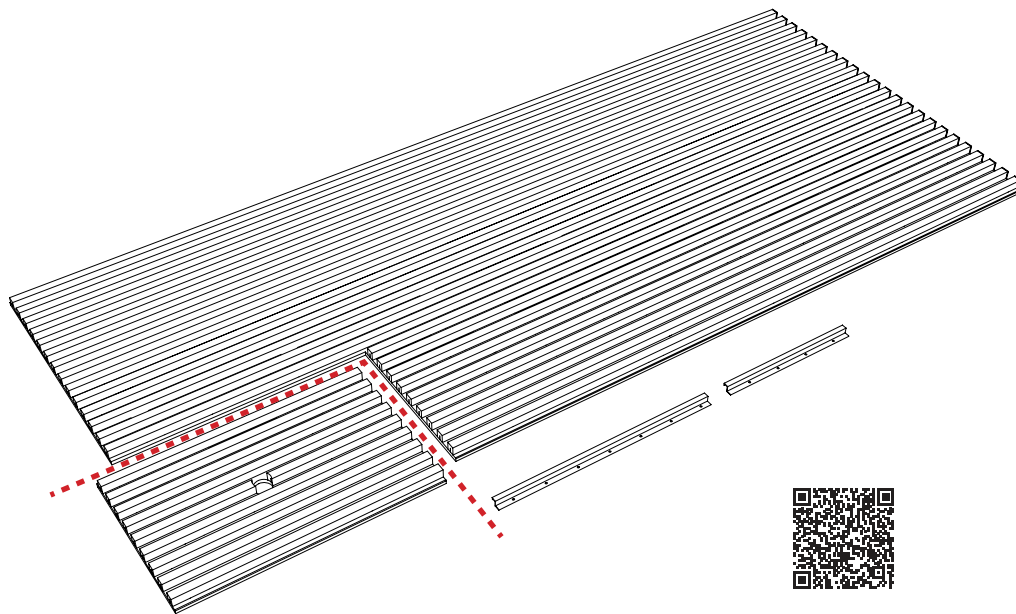
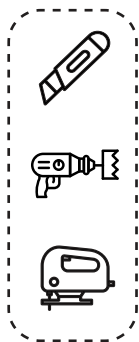

 Online Video Available

2 Install Z-Clip profiles at the back of the panel.

Install the profiles using included M4 11.5mm screws. If required, profiles can be cut on site using a metal blade jig saw or blade saw. The Z-Clip profiles need to be installed along the tabs extending at the back of the panel.

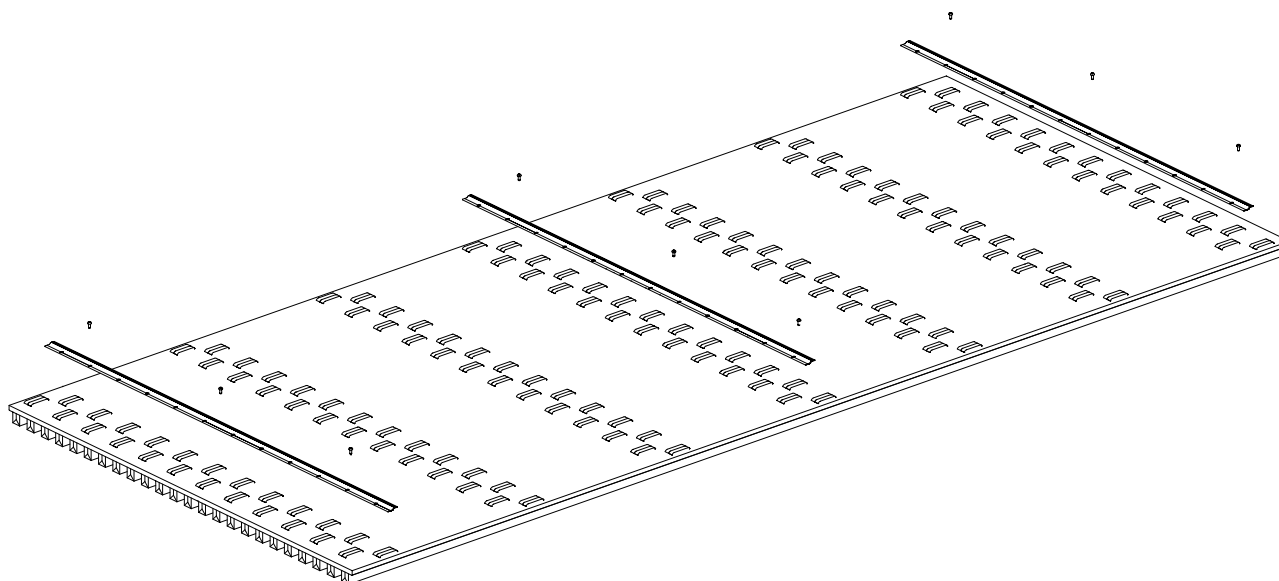

Track Wall Panels

Installation Overview





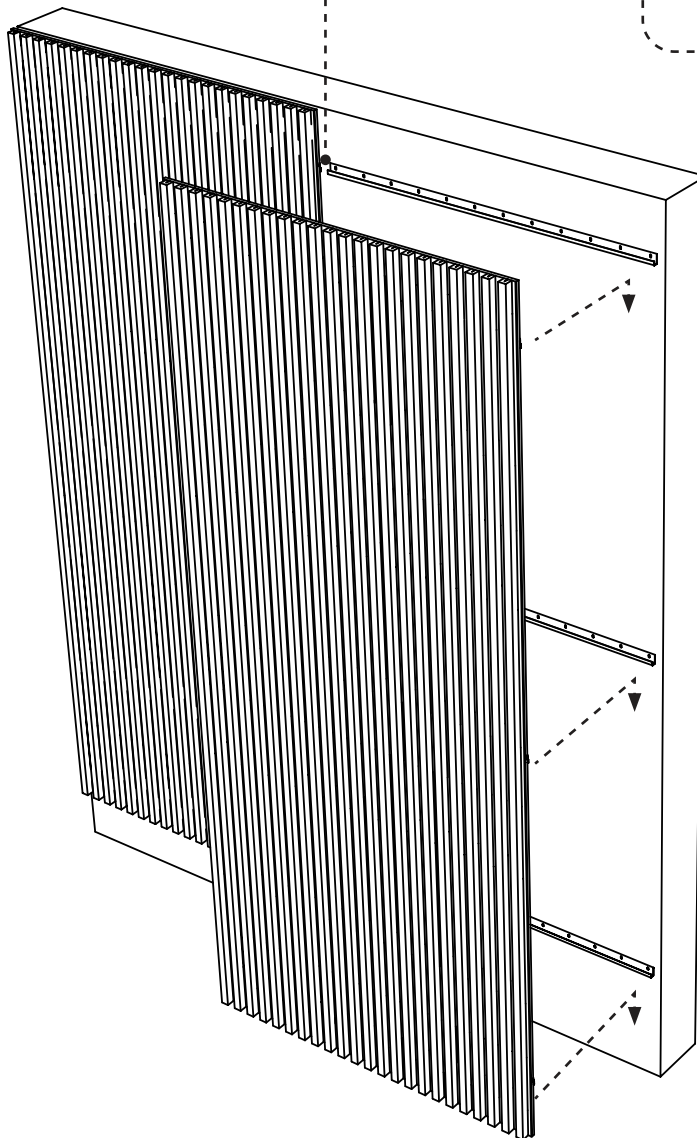
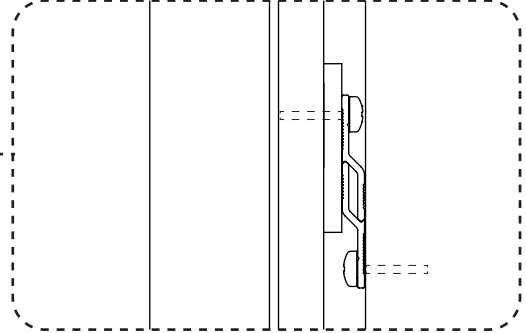



1 Install counter profiles to the wall.





Measure and install counter profile to the wall using hardware suitable for the type of the wall (not included)











ARCHISONIC® Felt Colours

 Material brochure available

									
Name	Snow White	Milk	Cloud	Gull	Smoke	Ground	Charcoal	Slate	Raven
Code	500	404	103	144	442	108	542	444	550
NCS	S 0300-N	S 0502-Y	S 1002-B	S2502-Y	S 3005-R80B	S 5005-Y20R	S 7502-B	S 4500-N	S 8500-N

									
Name	Nordic Pine	Grove	Fern	Moss	Spearmint	Ice Blue	Succulent	Deep Sea	True Navy
Code	311	317	180	439	706	304	712	918	194
NCS	S 5030-G10Y	S 7020-G30Y	S6010-G90Y	S 2040-G40Y	S 1010-B90G	S 0510-B	S 3020-B30G	S 5020-R90B	S8005-B

									
Name	Lichen	Linen	Shell Pink	Jute	Warm Stone	Terracotta	Soft Coral	Honeycomb	Sunshine
Code	160	107	102	920	105	239	516	139	846
NCS	S4005-Y	S 1505-Y30R	S 0510-R30B	S 3010-Y30R	S 3010-Y50R	S 4040-Y70R	S 2020-Y90R	S 2050-Y20R	S 1040-Y10R

									
Name	Garnet	Hot Pink	Poster Red	Electric Orange	Winter Sky	Pacific Ocean	Midnight	Grape	Marine Blue
Code	724	140	662	464	410	432	810	540	864
NCS	S 5040-R10B	S 2060-R20B	S 1080-R	S 0580-Y70R	S 2020-R90 B	S 3040-B	S 7020-R70B	S 5040-R40B	S 4050-R70B

These NCS codes are the closest visual match available and may not be exact to blended fibres.

ARCHISONIC®

Colours

Experience our ARCHISONIC® Felt material with a stunning selection of 36 colours across 8 distinct families, thoughtfully curated by *Colour Hive* in London. Effortlessly combine colours harmoniously to suit your preferences. Discover more in our Materials brochure and order your free sample box today.

Colour fastness

Class 6
ISO 105-B02:A1

Order a free sample box



ARCHISONIC® Riftcut

A Synthesis of Nature and Innovation

Developed in collaboration with German veneer specialists Schotten & Hansen and Swiss designer Ina Rinderknecht, ARCHISONIC® Riftcut adds a natural touch to our acclaimed Felt range.



ARCHISONIC® Riftcut Flax 50

Colour options

The printed shades form the basis of 24 colour spectrum, offering interior designers a sophisticated range of options linked to natural dyes.



Sustainable Ink

CP65 and RoHS3 compliant



Order a free sample set



ARCHISONIC® Riftcut Natural Collection

Natural Collection colour sets

Riftcut Natural Collection (NC) is a natural wood shade extension to our bestselling Riftcut. Developed in collaboration with German veneer specialists Schotten & Hansen, ARCHISONIC® Riftcut NC introduces 3 different colour groups: elegant brights, essential mids and classical darks.



ELEGANT BRIGHTS



240 Pebble



241 Sunlit



242 Blush



ESSENTIAL MIDS



243 Malt

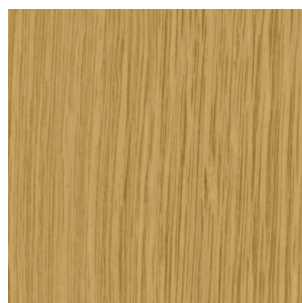

244 Honey



245 Mocha



CLASSICAL DARKS



246 Woodsmoke



247 Bourbon



248 Twilight

Sustainable Ink

CP65 and RoHS3 compliant



Order a free sample set



ARCHISONIC® Felt (Printed option)

Material Specification

Product Name	ARCHISONIC® Felt	
Content	100% PET (60% certified post-consumer content)	
Thickness¹	12mm (0.47")	
Max. Size	1200x2800mm (47"x110")	
Acoustic^{2, 4}	ASTM: NRC=0.9 ISO: α_w = 0.95	
Density¹	2400 g/m ² (0.49 lbs/ sqft)	
Colour	33 printed finishes.	
Maintenance	To prevent dust and stains, regularly dust or vacuum with a soft brush. Avoid tools that might scratch the surface. Use mild detergents sparingly for tough stains, blotting instead of rubbing with a microfiber cloth. Test cleaning methods on a hidden area first to check for adverse effects.	
Lead Time^{3, 4}	21 days	
Fire Rating⁴	DIN EN 13501-1: B-s1, d0	ASTM E84 Class A
VOC Emission⁴	28 Days French Regulation A+ ASTM E84 Pass Bream® (International, UK, NL, SE, NOR) Exemplary CDPH (CDPH/EHLB/Standard-Method V1.2) Pass	
Certifications⁴	Declare label, Cradle to Cradle, UL Environmental Product Declaration, Member of US Green Building Council, Ecobau 1st Priority, Climmate-KIC, VOC emissions in LEED EQ credit (low-emitting products), SCS Recycled Content	
Ink Certifications	UL Greenguard, No NVC, No VOCs, No TPO, Vegan, compliant with California Prop65 (CP65) and European Directive RoHS3	
Durability	Contract	

1 - all values are nominal 2 - measured with 300mm air cavity 3 - depending on the location and type of product



Track Wall Panels

Additional Information

Online Resources

A variety of resources are available online for all of our products. Please visit the product's page for more information.



CAD files



Spec sheets and
Installation Guide



Colour families



Instruction
videos



Associated
products specs.

Ordering Process

Our experienced team of Project Consultants will guide and support you throughout the order process. We fulfill the majority of our orders in as little as 21 days¹ from your first point of contact, allowing you to focus on what truly matters to you.



Contact our
consultant

Quote¹

48h



Order Confirmation

Production¹

14-21 days



Dispatch

Transit

location based



Delivery

Contact Us

Ready to make an impact? We are just an email or call away to discuss your project and answer any question.



+41 41 244 14 00



connect@impactacoustic.com



Online form

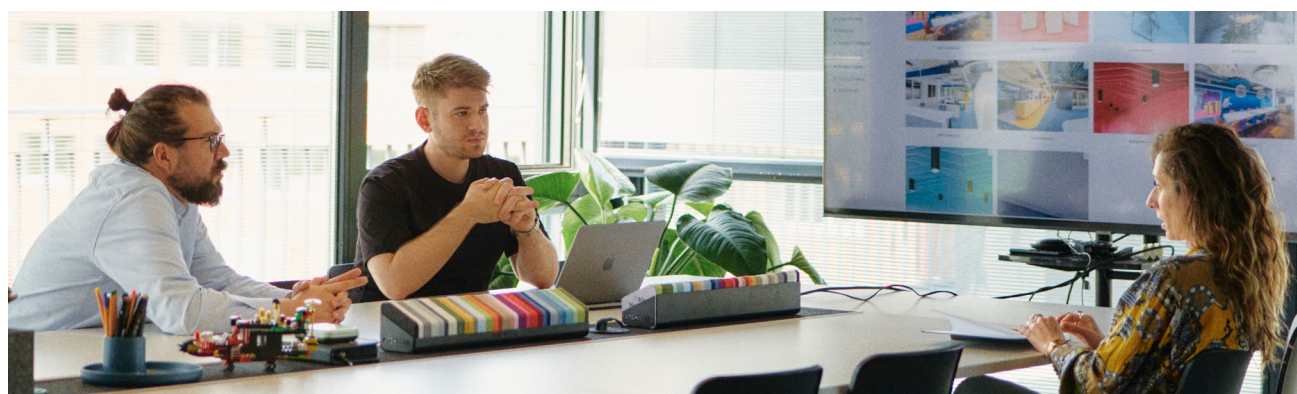

¹ - Quote and Production times may vary.

**#We
Make An
Impact**

connect@impactacoustic.com | www.impactacoustic.com